

VG4258



VCR User's Guide



We bring good things to life.

Important Information

WARNING

To reduce the risk of fire or shock hazard, do not expose this product to rain or moisture.

WARNING

RISK OF ELECTRIC SHOCK DO NOT OPEN

TO REDUCE THE RISK OF ELECTRIC SHOCK, DO NOT REMOVE COVER (OR BACK). NO USER SERVICEABLE PARTS INSIDE. REFER SERVICING TO QUALIFIED SERVICE PERSONNEL.

 This symbol indicates "dangerous voltage" inside the product that presents a risk of electric shock or personal injury.

 This symbol indicates important instructions accompanying the product.

Cautions

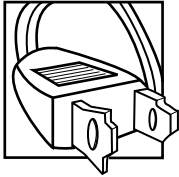

Caution: To prevent electric shock, match wide blade of plug to wide slot, fully insert.

Attention: Pour éviter les chocs électriques, introduire la lame la plus large de la fiche dans la borne correspondante de la prise et pousser jusqu'au fond.

Do not defeat the safety feature of the plug. The wide blade fits into the wall socket only one way. If you need an extension cord, make sure it matches the plug of the product.

Refer to the identification / rating label (normally located on the back of the product) for the proper operating voltage for this product.

FCC Regulations state that unauthorized changes or modifications to this equipment may void the user's authority to operate it.

Note To Cable TV Installer

This reminder is provided to call your attention to Article 820-40 of the National Electrical Code (Section 54 of the Canadian Electrical Code, Part 1) which provides guidelines for proper grounding and, in particular, specifies that the cable ground shall be connected to the grounding system of the building as close to the point of cable entry as practical.

Product Registration

Please fill out the product registration card and return it immediately. Returning this card allows us to contact you if needed.

Keep your sales receipt to obtain warranty parts and service and for proof of purchase. Attach it here and record the serial and model numbers in case you need them. The numbers are located on the back of the product.

Model No. **VG4258** _____

Serial No. _____

Purchase Date: _____

Dealer / Address / Phone: _____

Table of Contents

Important Information

Warnings _____	i
Cautions _____	i
Note to Cable TV Installer _____	i
Product Registration _____	i

Hooking Up the VCR

Choosing a Hookup _____	2
Antenna or Cable System Without a Cable Box _____	3
Cable System With Cable Box to Unscramble All Channels _____	4
Cable System With Cable Box to Unscramble Pay Channels Only _____	5
Connecting Two VCRs for Copying Tapes _____	6

Setting Up the VCR

Startup	
Check Accessories With VCR _____	7
Insert Batteries in Remote _____	7
Turn on TV _____	7
Turn on VCR _____	7
Select the Language/Seleccione el Idioma/Sélectionner la Langue _____	8
Place Channels in VCR's Memory _____	8
Add or Remove Channels from VCR's Memory _____	9
Set the Time and Date _____	9
Set the Auto TV/VCR Feature _____	9
Use TV•VCR Button _____	10
Select the Display Panel Brightness _____	10

Using the Remote Control

Component, VCR, and TV Buttons _____	11-12
Controlling a VCR _____	13
Controlling a TV _____	14

Playing a Tape

Playback _____	15
Using the Playback Features	
Auto Play _____	15
Pause for Stop-Action _____	16
Frame Advance _____	16
Slow Motion _____	16
Picture Search _____	17

Automatic Tracking _____	17
Manual Tracking _____	17
DISPLAY Button _____	18
Time Counter _____	18
Commercial Scan _____	19
Index Search _____	19
Go-To Search _____	19
Tape Playback: HI-FI/LINEAR/MIX Feature _____	20

Recording a Program

Recordings _____	21
Recording Speeds _____	21
Normal Recording	
To Make a Recording _____	21
Watch a TV Channel While VCR is Recording a Different Channel _____	21
Recording While You're Away	
VCR Plus+ Recording _____	22-24
Timer Recording _____	25
Select Cable Box Viewing Channel _____	26
Checking or Clearing Timer Recordings _____	27
Timer Recording From the VCR's Line Input _____	27
One Touch Recording _____	28
Recording Broadcast Stereo TV or SAP _____	29
Recording Audio Only _____	30
Recording Features	
Recording Pause _____	30
Using Two VCRs for Copying and Editing Tapes _____	31
Using Dual Remote with AutoEdit _____	31

References

Location of Controls	
Front Panel _____	32
Back Panel _____	33
Display Panel _____	34
Specifications _____	35
Cleaning the VCR _____	35
Trouble Checks _____	36-37
Limited Warranty _____	38
Index _____	39-40

Choosing a Hookup

The hookups on pages 3 through 5 are divided into two hookup types: Basic (A) and Advanced (B).

The basic hookup shows the backs of TVs that have only an antenna/cable connection. It is the easier of the two and additional accessories may not be needed.

The advanced hookup shows the VCR hooked up to a TV with audio and video jacks, with the advanced hookup *on page 6* using a signal splitter. This hookup may improve the picture quality as well as convenience of operation.

Answer the questions to choose the hookup for your VCR.

1. How does your TV receive signals?

Choose one answer from below.

- A. Outside antenna – Turn to page 3.
- B. Rabbit ears (set-top) and/or bow tie antenna – Turn to page 3.
- C. Cable System – Go to question 2.

2. What type of Cable-TV system* do you have?

Choose one answer from below.

- A. Cable without a box – Turn to page 3.
- B. Cable box to unscramble all the channels – Turn to page 4.
- C. Cable box to unscramble only pay channels, such as HBO, Showtime, Cinemax, etc. – Turn to page 5.

*You may need to contact your local cable company for assistance.

Optional Hookups

How to hook up two VCRs for copying tapes.

- A. Select a hookup by answering questions 1 and 2 above.
- B. Then, modify the connections as shown on page 6.

Antenna or Cable System Without a Cable Box

A. Basic hookup.

Use this hookup for a basic connection which requires fewer accessories.

1. Set the CH 3◀▶4 switch on back of VCR to either channel 3 or 4.

Tune the TV to this channel and use the TV•VCR button to watch the VCR.

2. Connect as shown.

This connection may require additional accessories not provided.

3. Plug in power cords of VCR and TV.

4. **Continue to page 7.**

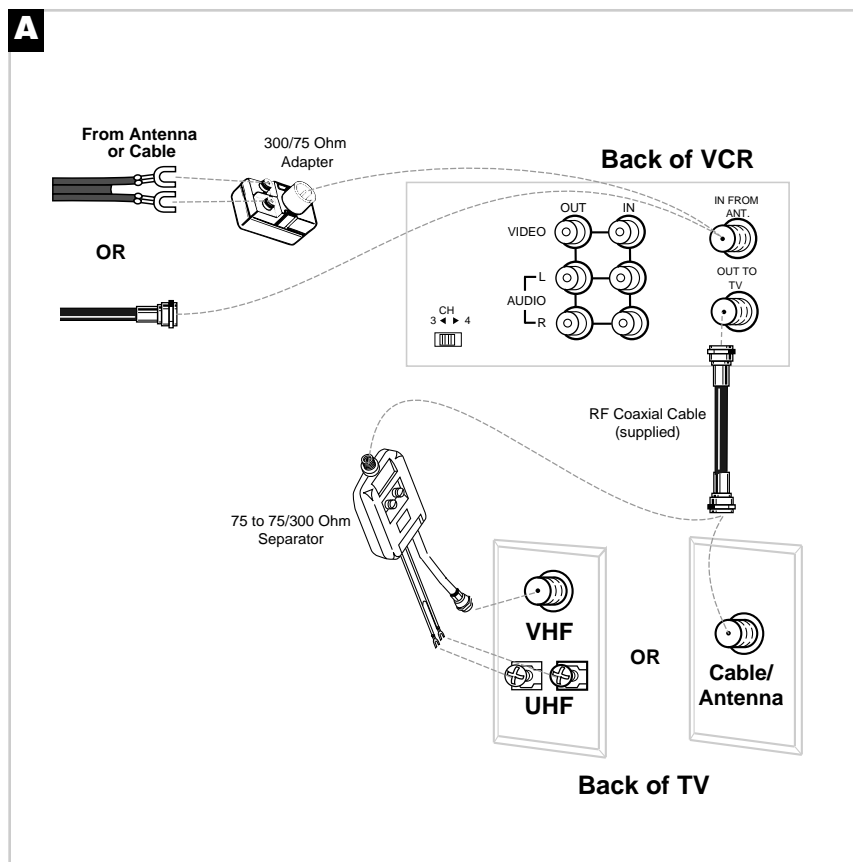

B. Advanced hookup.

Use this hookup for slightly improved picture quality, Hi-Fi stereo playback and more convenient operation — use of TV•VCR button is not required.

1. Connect as shown.

This connection requires additional accessories not provided. A Y-adaptor may be required to hear sound from both channels if your TV is not stereo.

2. Plug in power cords of VCR and TV.

3. **Continue to page 7.**

Tune the TV to its LINE (audio/video) input to watch the VCR. All pay channels are viewed through the VCR.

Set the AUTO TV/VCR feature to OFF. See page 9.

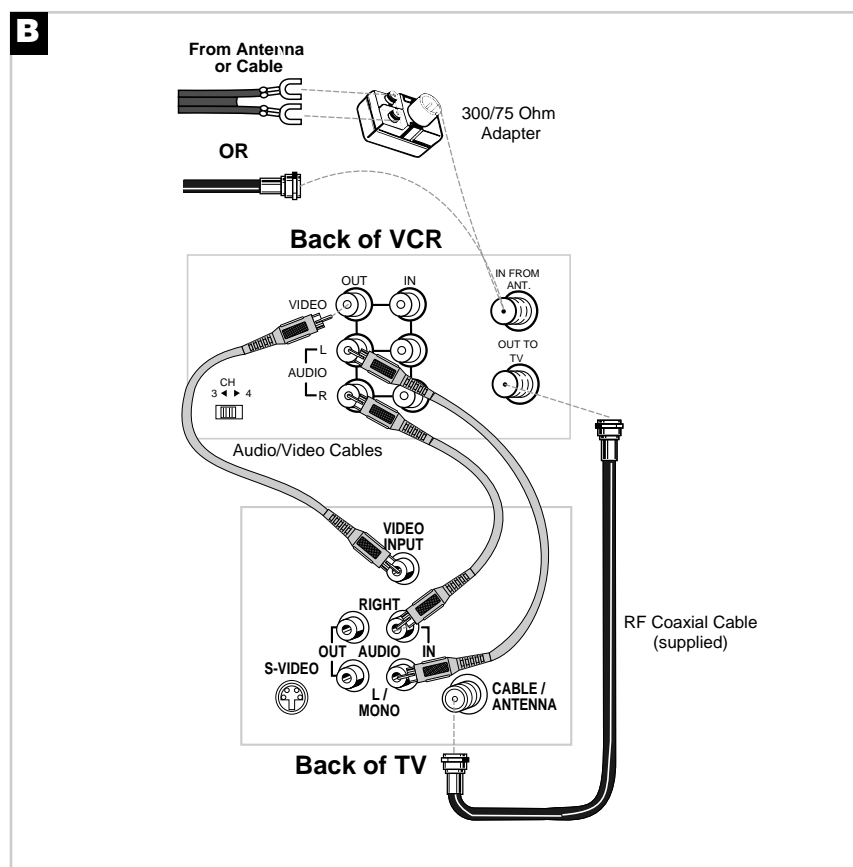

Cable System With Cable Box to Unscramble All Channels

A. Basic hookup.

Use this hookup for a basic connection which requires fewer accessories.

1. Set the CH 3◀▶4 switch on back of VCR to either channel 3 or 4.
Tune the TV to this channel and use the TV•VCR button to watch the VCR.
2. Connect as shown.
This connection may require additional accessories not provided.
3. Plug in power cords of VCR, TV, and cable box.
4. **Continue to page 7.**

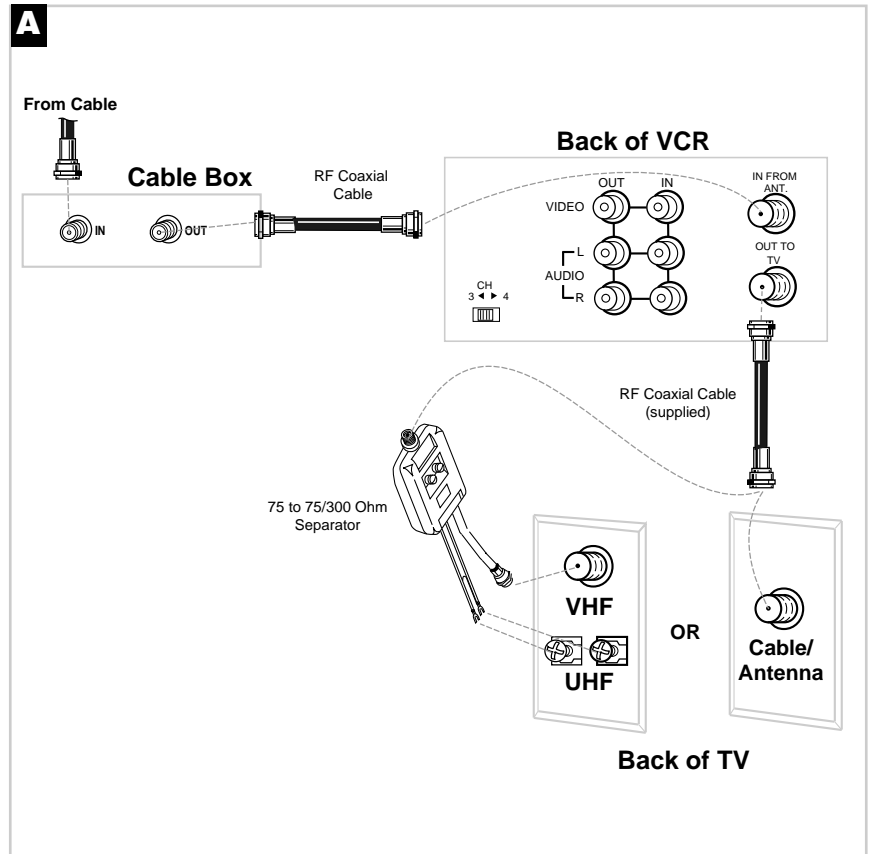

B. Advanced hookup.

Use this hookup for slightly improved picture quality, Hi-Fi stereo playback and more convenient operation — use of TV•VCR button is not required.

1. Connect as shown.
This connection requires additional accessories not provided. A Y-adaptor may be required to hear sound from both channels if your TV is not stereo.
2. Plug in power cords of VCR and TV.
3. **Continue to page 7.**
Tune the TV to its LINE (audio/video) input to watch the VCR. All pay channels are viewed through the VCR.
Set the AUTO TV/VCR feature to OFF. See page 9.

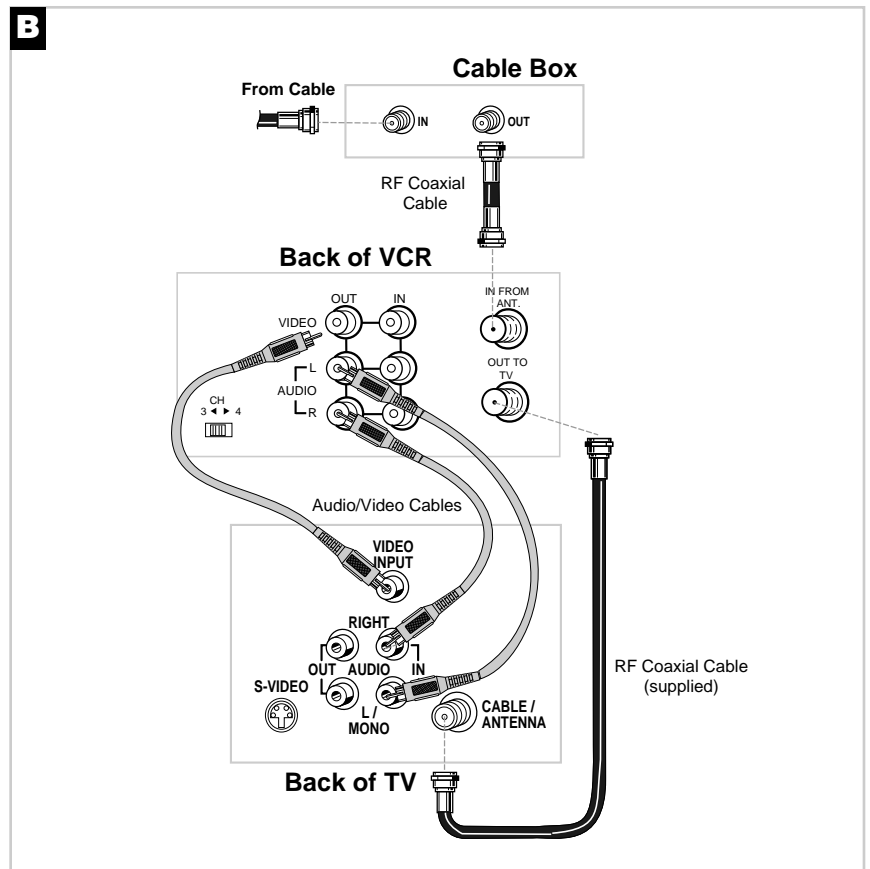

Cable System With Cable Box to Unscramble Pay Channels Only

(such as HBO, Showtime, Pay-Per-View, etc.)

A. Basic hookup.

Use this hookup for a basic connection which requires fewer accessories.

1. Set the CH 3◀▶4 switch on back of VCR to either channel 3 or 4.
Tune the TV to this channel and use the TV•VCR button to watch the VCR.
2. Connect as shown.
This connection may require additional accessories not provided.
3. Plug in power cords of VCR, TV, and cable box.
4. **Continue to page 7.**

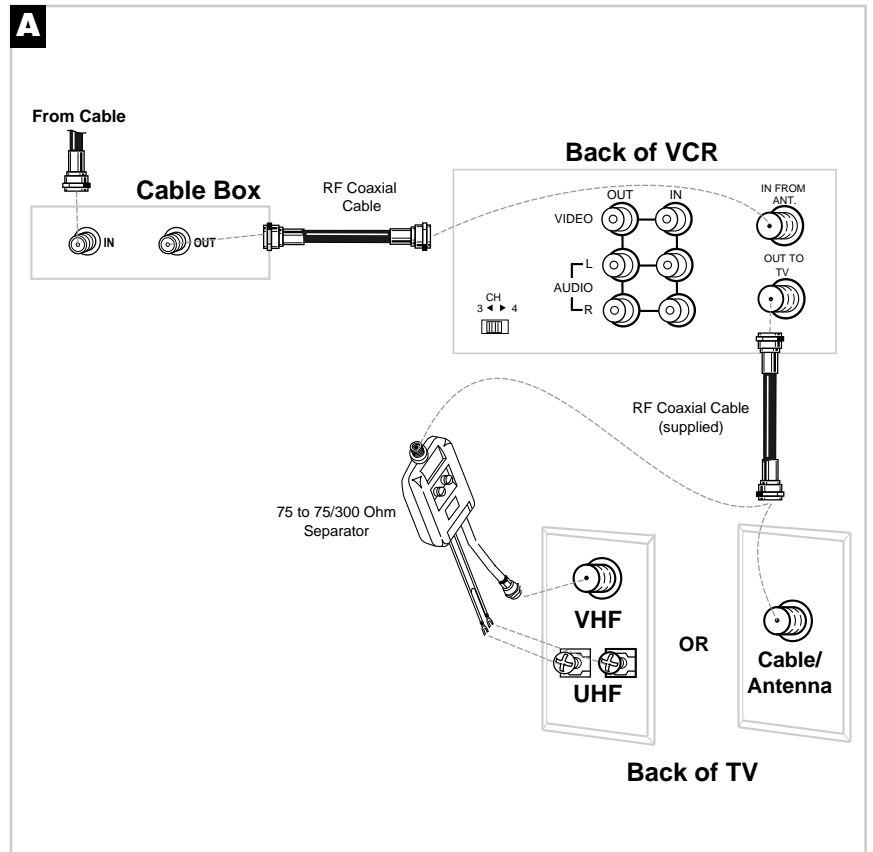

B. Advanced hookup.

Use this hookup for slightly improved picture quality, Hi-Fi stereo playback and more convenient operation — use of TV•VCR button is not required.

1. Connect as shown.
This connection requires additional accessories not provided. A Y-adaptor may be required to hear sound from both channels if your TV is not stereo.
2. Plug in power cords of VCR and TV.
3. **Continue to page 7.**
Tune the TV to its LINE (audio/video) input to watch the VCR. All pay channels are viewed through the VCR.

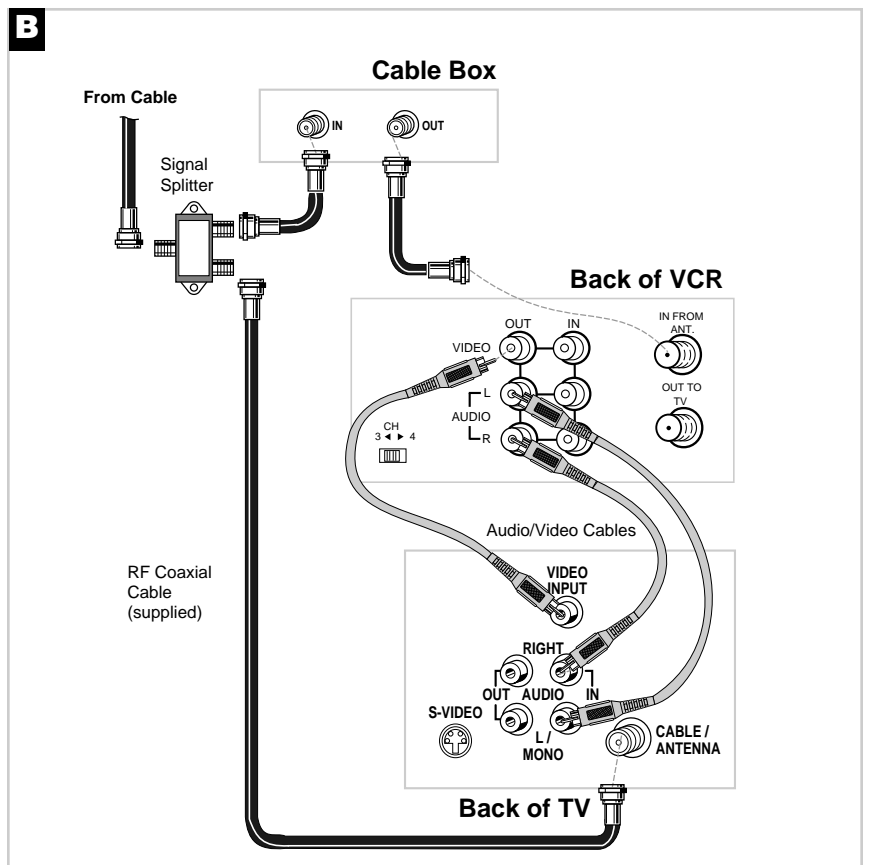

Connecting Two VCRs for Copying Tapes

Option A Hookup.

Use this hookup for a basic connection which requires fewer accessories.

1. Select a hookup from pages 2 through 5 and then modify with this connection.
2. Set the CH 3◀▶4 switch on the playback VCR to either channel 3 or 4.
Tune the recording VCR to this channel to receive the signal from the playback VCR.
3. Connect as shown.
4. Plug in power cords of VCRs and TV.
5. **Continue to page 7.**

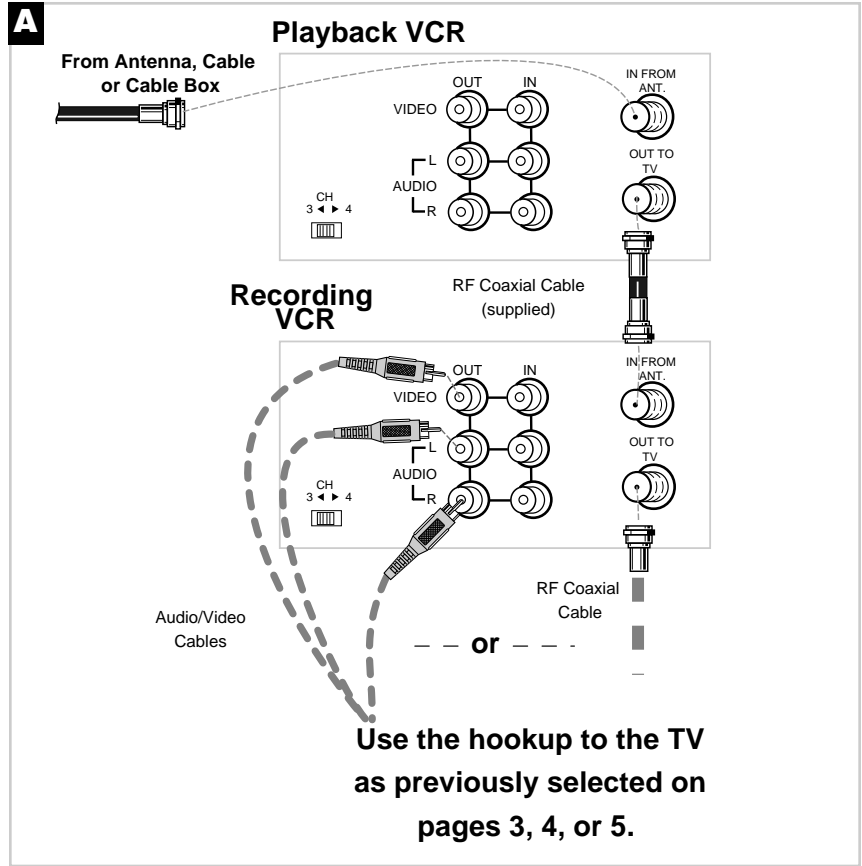

Option B Hookup.

Use this hookup for slightly improved picture quality, Hi-Fi stereo playback and more convenient operation — use of TV•VCR button is not required.

1. Select a hookup from pages 2 through 5 and then modify with this connection.
2. Connect as shown.
This connection requires additional accessories not provided. A Y-adaptor may be required to hear sound from both channels if your other VCR is not stereo.
3. Plug in power cords of VCRs and TV.
4. **Continue to page 7.**
Select the LINE (audio/video) input on the recording VCR to receive the signal from the playback VCR.

Caution: The unauthorized recording of television programs and other materials may infringe the rights of others.

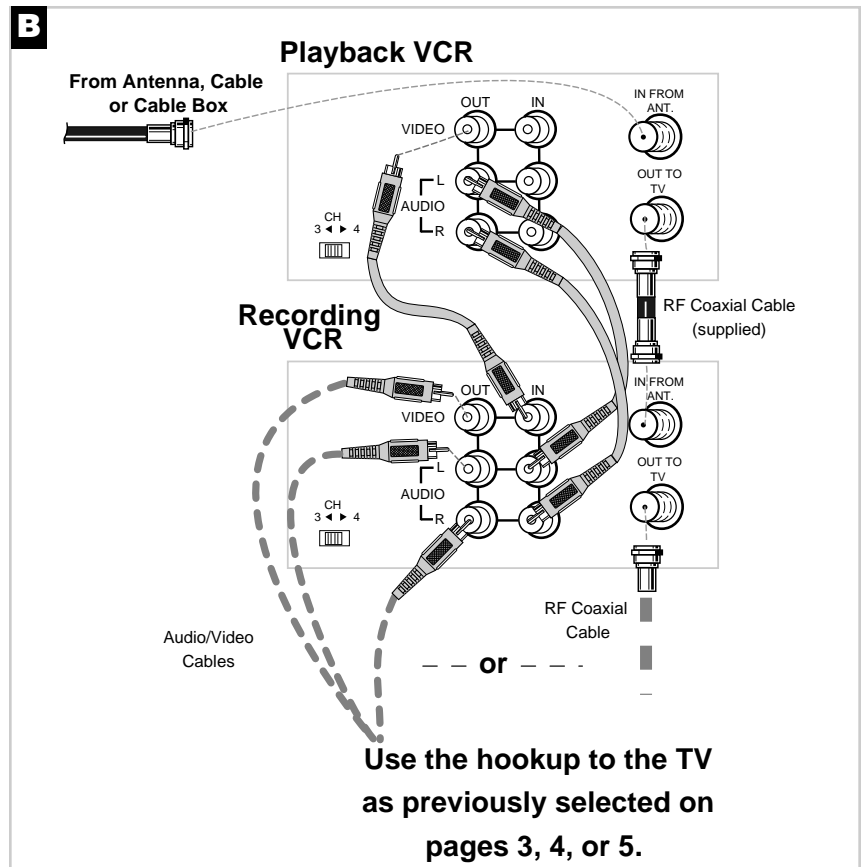

Startup

1. Check accessories with VCR.

Contact your dealer if any items are missing.

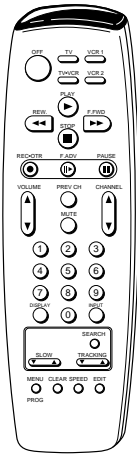

Remote
(Stock No. 221425)

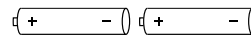

2 "AA" Batteries



RF Coaxial Cable
(Stock No. 207417)

2. Insert batteries in remote.

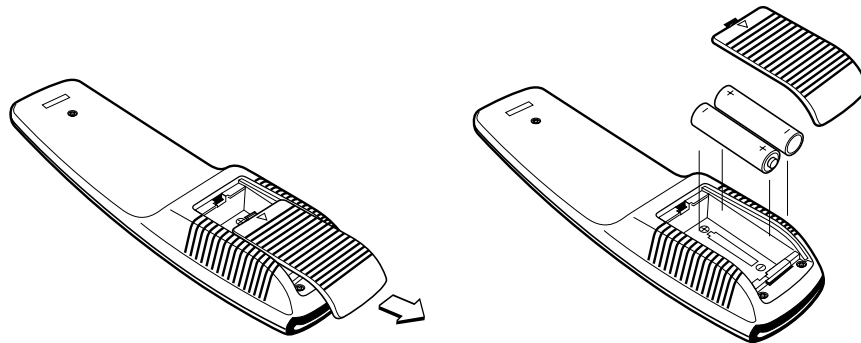

3. Turn on the TV.

- A. Turn on the TV.
- B. If you used one of the basic hookups, tune the TV to the channel selected with the 3◀▶4 switch on back of VCR.
If you used one of the advanced hookups, tune the TV to the TV's video input.
(See TV owner's manual for details.)

4. Turn on the VCR.

Press VCR1 on the remote.

Startup

5. Select the language/Seleccione el idioma/ Sélectionner la langue.

The VCR displays the on-screen menus in the English, Spanish or French language. The word “Language” cycles through the different languages when the VCR Main Menu is displayed on the TV screen. The arrow indicates which language is selected.

- A. Press MENU on remote to display the VCR MAIN MENU.
- B. Press 7 to display the LANGUAGE or IDIOMA or LANGUE menu. (English: LANGUAGE; Spanish: IDIOMA; French: LANGUE).
 - Press 1 to have the menus displayed in English (Ingles).
 - Press 2 to have the menus displayed in Spanish (Español).
 - Press 3 to have the menus displayed in French (Français).

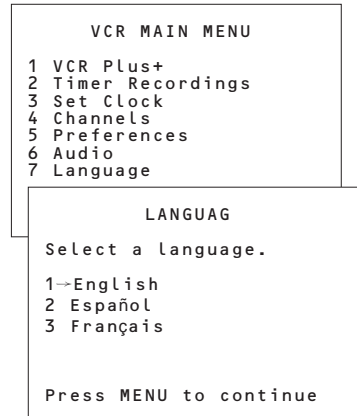

6. Place channels in the VCR's memory.

The AUTO CHANNEL SEARCH feature memorizes the channel list available through your signal type—cable or antenna. The signal type is automatically selected when you auto channel search. Also, if you change your signal system, you must perform AUTO CHANNEL SEARCH again.

Wait until the channel numbers stop changing. This takes about one to two minutes. The TV tunes to the lowest channel found. Pressing CHANNEL up or down selects only the active channels.

- A. Press MENU to display the VCR MAIN MENU on the TV screen. If this menu does not appear:
 - Make sure the TV is tuned to same channel as the CH 3/4 switch on the VCR or the TV's video input (refer to TV's manual).
 - If you use a basic hookup, check the VCR indicator in display panel — it should be on. Press TV•VCR to turn it on.
 - Check the connections.
- B. Press 4 to display the CHANNELS menu.
- C. Press 1 to begin AUTO CHANNEL SEARCH.

The VCR automatically selects the CABLE (cable TV) or ANTENNA signal. For cable connection, 125 channels are searched; for an antenna connection, 69 channels are searched.

To change the Signal Type:

- A. Follow steps A-B above.
- B. Press 3 to switch the Signal Type between CABLE and ANTENNA.

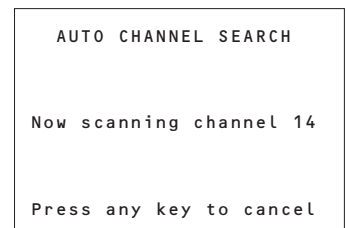
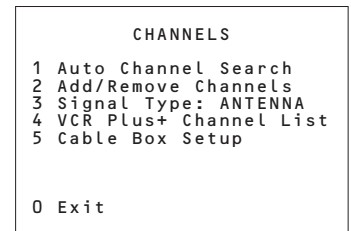
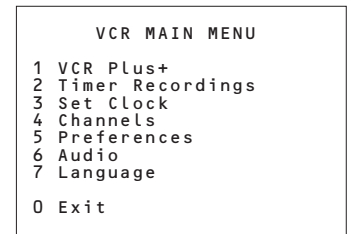

Startup

7. Add or remove channels from the VCR's memory.

You may want to add or remove channels if some of the channels are not active, have weak signals, or you do not want to watch them.

- A. Press MENU on the remote to display the VCR MAIN MENU on the TV screen.
- B. Press 4 to display the CHANNELS menu.
- C. Press 2 to display the ADD/REMOVE CHANNEL display.
- D. Follow the directions on the screen.
- E. Add or remove more channels using the CHANNEL up and down buttons.

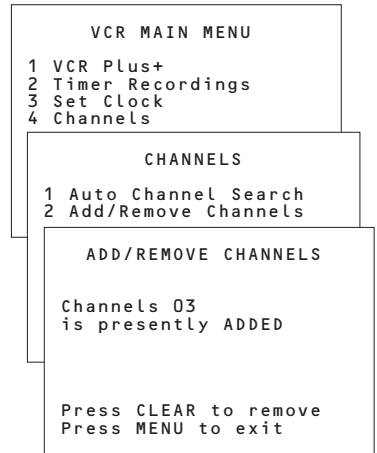

8. Set the time and date.

When you first turn on the VCR, --:-- appears in the clock area of the VCR's display panel.

- A. Press MENU on remote to display the VCR MAIN MENU on the TV screen.
- B. Press 3 to display SET TIME AND DATE.
- C. Enter the time and date with the number buttons on the remote.
 - Press 0 before single-digit numbers.
Example: press 0, then 5, then 0, then 7 for a time of 5:07. Press 1 for AM or 2 for PM.
 - Press CLEAR on the remote to change incorrect entries.
- D. Press MENU on remote to remove SET TIME AND DATE from the TV screen and start the clock. The time appears in the VCR's display panel and the time and date appears on the TV screen when you press DISPLAY.

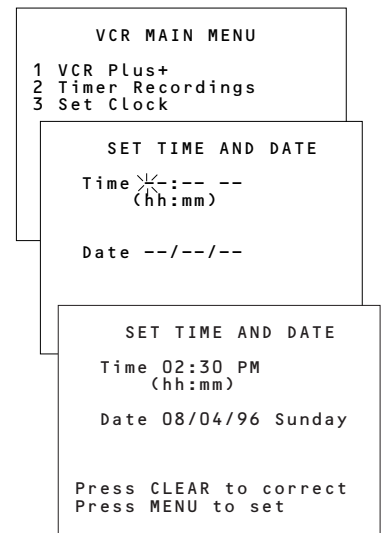

9. Set the AUTO TV/VCR feature.

Skip this step if you used one of the basic hookups.

If you connected your VCR using the TV's video input, you can prevent the VCR indicator from turning on automatically and interrupting your TV signal.

- A. Press MENU on remote to see VCR MAIN MENU on the TV screen.
- B. Press 5 to display PREFERENCES.
- C. Press 3 to select Auto TV/VCR: ON or OFF.
 - Select ON if you used one of the basic hookups and watch your VCR on channel 3 or 4 of your TV. Press the TV•VCR button to turn the VCR indicator on or off to switch between the picture coming from the VCR or television channels.
 - Select OFF if you used one of the advanced hookups and watch your VCR on the video input channel of your TV. The VCR indicator will not turn on automatically, nor interrupt the TV signal.
Pressing TV•VCR on the remote will still turn the VCR indicator on or off.

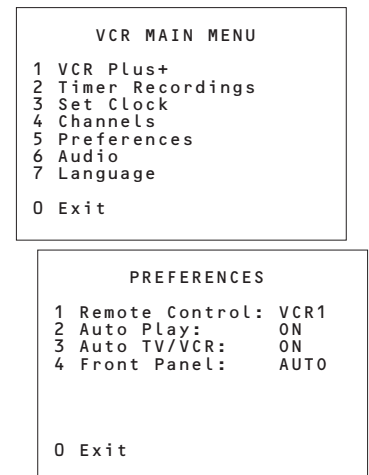

Startup

10. Use TV•VCR button.

Skip this step if you used one of the advanced hookups.

When using one of the basic hookups, the TV•VCR button lets you switch between the picture coming from the VCR or the picture from the TV channel. This button lets you record a program on the VCR while watching another channel on the TV. *Details are on page 21.*

- A. Press VCR1 to set the remote to control the VCR.
- B. Press TV•VCR to see the picture from the VCR.
The VCR indicator lights in the display panel.
- C. Press CHANNEL up or down to change channels on the VCR.
The channel number changes in the display panel.
- D. Press TV•VCR to see the TV channels.
The VCR indicator does not light in the display panel. Change channels using the TV's remote.
- E. Return the TV to the VCR viewing channel — CH3 or CH4.
- F. Press VCR1, then TV•VCR to switch back to the picture from the VCR.

11. Select the display panel brightness.

You can change the brightness level of the fluorescent VCR display panel.

- A. Press MENU on remote to see VCR MAIN MENU on the TV screen.
- B. Press 5 to display PREFERENCES.
- C. Press 4 to select Front Panel: AUTO, DIM or BRIGHT.
 - Select AUTO to keep the display panel bright when the VCR is on and dim when it is off.
 - Select DIM to keep the display panel dim whenever the VCR is on or off.
 - Select BRIGHT to keep the display panel bright whenever the VCR is on or off.

```

VCR MAIN MENU
1 VCR Plus+
2 Timer Recordings
3 Set Clock
4 Channels
5 Preferences
6 Audio
7 Language
0 Exit
    
```

```

PREFERENCES
1 Remote Control: VCR1
2 Auto Play: ON
3 Auto TV/VCR: ON
4 Front Panel: AUTO

0 Exit
    
```

Buttons

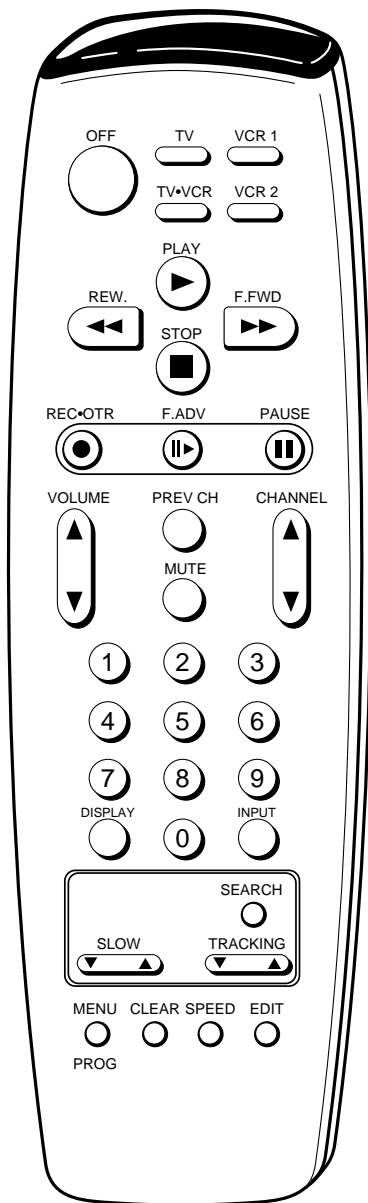

Component Buttons

Press one of the buttons to set the remote to operate that component.

TV

Turns on a compatible GE, RCA, or ProScan TV and sets the remote to control the TV.

See page 14.

Used with OFF button to turn on compatible TV after TV button is programmed. *See page 14.*

VCR1

Turns on a compatible GE, RCA, or ProScan VCR and sets remote to control the VCR.

VCR2

Turns on a compatible GE, RCA, or ProScan VCR and sets remote to control the VCR when it has been setup. *See page 13.*

VCR Function Buttons

Press VCR1 (VCR2) to set remote to control the VCR to use the function buttons.

CHANNEL up or down

Selects next higher or lower channel in the VCR's channel memory.

CLEAR

Resets time counter to 0:00:00.

Allows you to change entries when setting the clock or VCR for a VCR Plus+ or timer recording.

DISPLAY

Shows VCR operating displays on the TV screen.

Displays the time counter.

EDIT

Signals two properly connected VCRs to begin copying a tape. *See page 31.*

F.ADV (Frame Advance)

Lets you view one frame with each press of the button when tape is in stop-action pause.

F.FWD (Fast Forward)

Fast forwards the tape when the VCR is stopped.

Searches the picture in forward motion during playback.

INPUT

Turns the line input on or off. LINE appears in the VCR's display panel and VIDEO appears on the TV screen.

Line input refers to the signal coming from the component connected to the audio/video jacks on the back of the VCR.

MENU PROG

Displays the VCR MAIN MENU on the TV screen.

Used to program the VCR.

Removes a menu from the screen.

Numbers (0 through 9)

Select a channel up to 99 by pressing two numbers.

Select a cable channel over 99 by pressing and holding 1 until 1-- appears on the screen. Then press the other two numbers.

OFF

Turns off VCR when remote is set to control the VCR.

Buttons

VCR Function Buttons *(continued)*

PAUSE

Pauses action for viewing during playback.

Pauses recording to prevent recording of unwanted scenes.

PLAY

Plays a tape.

PREV CH (Previous Channel)

Switches between two channels.

Select one channel and then select another. Press PREV CH to switch between the two channels.

Turns off VCR when remote is set to control the VCR.

REC•OTR

Starts VCR recording.

Used for one touch recording. *See page 28.*

REW. (Rewind)

Rewinds the tape when the VCR is stopped.

Searches the picture in reverse motion during playback.

SEARCH

Displays INDEX and GO-TO SEARCH menus on TV.

Advances tape 60 or 120 seconds during playback.

SLOW up or down

Used for slow-motion playback.

SPEED (Tape Speed)

Selects a recording speed (SP or SLP).

STOP

Stops the normal functions such as record, playback, rewind, fast forward, and pause of the VCR.

TRACKING up or down

Lets you manually reduce the streaks that may appear on the picture during play or pause.

Reduces picture "jitter" during stop-action playback.

TV•VCR

Switches the picture signal so that it either comes from the VCR or the TV channel. *See page 10.*

TV Function Buttons

Press the TV button to set remote to control a compatible TV. Some buttons may not work with the TV.

CHANNEL up or down

Selects next higher or lower channel in the TV's channel memory when remote is set to control a TV.

CLEAR

Removes menus or status displays from the screen.

DISPLAY

Shows the status displays on the screen.

Removes menus or displays from the screen.

MUTE

Turns the TV sound on or off.

Numbers (0 through 9)

Select a channel up to 99 by pressing two numbers.

You can also select a cable channel over 99 by pressing and holding 1 until 1-- appears on the screen. Then press the other two numbers.

OFF

Turns off a compatible TV when remote is set to control that TV.

Used with TV button to turn on a compatible TV (other than GE, RCA, or ProScan) when remote is programmed to control that TV. *See page 14.*

PREV CH (Previous Channel)

Switches between two channels.

Select one channel and then select another. Press PREV CH to switch between the two channels.

VOLUME up or down

Raises and lowers sound of TV.

Controlling a VCR

The VCR's remote controls two compatible GE, RCA, or ProScan VCRs with the VCR1 and VCR2 buttons. Most compatible VCRs automatically respond to VCR1 without being programmed. If you own two compatible VCRs, test them to see if VCR1 turns on both VCRs. If it does, then you may want to program this VCR to respond to the VCR2 button on the remote.

Program the VCR for Remote Control

Set the Remote Control feature of the VCR to the VCR1 or VCR2 position. The remote then controls the VCR with either the VCR1 or VCR2 button — whichever position you select in the menu.

1. Press MENU to display the VCR MAIN MENU.
2. Press 5 to display PREFERENCES.
3. Press 1 to activate the Remote Control feature.
4. Press VCR1 or VCR2 to change the setting and program this VCR to respond to the VCR1 or VCR2 button — whichever you select.

Important Reminder: Remember you must press VCR1 or VCR2 on the remote — whichever you selected in the menu — before the remote will operate this VCR.

```
VCR MAIN MENU
1 VCR Plus+
2 Timer Recordings
3 Set Clock
4 Channels
5 Preferences
6 Audio
7 Language
0 Exit
```

```
PREFERENCES
1 Remote Control: VCR1
2 Auto Play:      ON
3 Auto TV/VCR:   ON
4 Front Panel:   AUTO
0 Exit
```

```
PREFERENCES
( PRESS VCR2 TO CHANGE )
2 Auto Play:      ON
3 Auto TV/VCR:   ON
4 Front Panel:   AUTO
0 Exit
```

Controlling a TV

The VCR's remote is preprogrammed to control the basic functions of a compatible GE, RCA, or ProScan TV. The remote can also be set up to control other manufacturer's brands. To program the remote, enter the remote code number that corresponds to your brand.

Program the remote for a TV

1. Turn on the TV.
2. Point the VCR remote at the TV.
3. Hold the TV button and press the remote number button to enter the code for your brand. If the TV changes channels when you press CHANNEL up or down, setup is complete.
4. Release the buttons.
5. Repeat steps 2 – 4 with a different code if the first one does not work.

Brand	Remote Button	Brand	Remote Button
Admiral	1,6,9	Panasonic	(CH Up)
Akai	6	Philco	6,8
AOC	6	Philips	4
Centuricon	9	Portland	8
Coronado	8	Prism	(CH Up)
Curtis Mathes	1,9	ProScan	1
Daytron	9	Quasar	(CH Up)
Emerson	6,8	RCA	1
Fisher	5	Sampo	9
GE	1	Samsung	8,9
Goldstar	6,8	Scott	9
Hitachi	0,8	Sears	1,5,7
JCPenney	6,9	Sharp	8
KMC	8	Signature 2000	6,9
KTV	6,8	Sony	3
MGA	9	Sylvania	4,9
Magnavox	4,8,9	Teknika	4,8
Marantz	6, (CH Dn)	Toshiba	7
Mitsubishi	6, (CH Dn)	Yorx	9
NEC	6,9	Zenith	2

* The remote may not be able to control every model TV of the brands listed.

Operate the TV

After you have set up your remote to control your TV, test the TV buttons to see which ones operate your TV.

1. Point the remote at the TV and press TV.
2. If TV does not turn on in step 1, press TV and then OFF.
3. Use the "TV Function Buttons" as described on page 12.

Helpful Hint: Notice the difference between the TV and VCR on-screen displays. This is one way to tell if the remote is set to control the VCR or the TV.

Playback

To play a tape

1. Turn on the TV and tune it to channel 3, 4, or TV's video input to see the picture from the VCR.
2. Insert a tape in the VCR.
 VCR automatically turns on. The cassette-in  indicator lights, and the VCR indicator lights if the Auto TV/VCR feature is set to ON. The tape automatically begins playback if the safety tab on the cassette has been removed and the Auto Play feature is turned on.

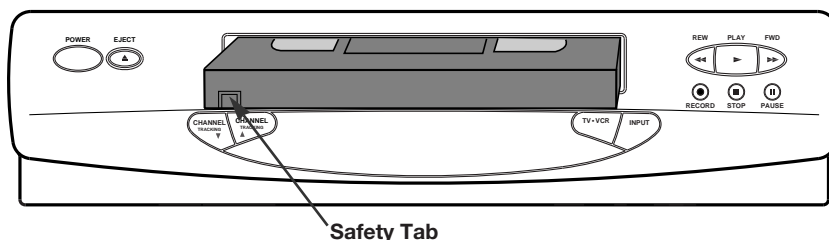

3. Press PLAY, if necessary. PLAY appears in the VCR's display panel.
4. Press TRACKING up or down to remove any streaks from the picture, if necessary. *Details are on page 17.*
5. Press STOP.
6. Press REW.

End of Tape

The VCR automatically rewinds the tape if it reaches the end of the tape during playback.

Power Off

If you press POWER while a tape is rewinding, the VCR turns off automatically when it is completely rewind.

7. Press EJECT on the VCR to eject the tape once it is completely rewind.

Using the Playback Features

Auto Play Feature

This feature lets you tell the VCR whether you want it to automatically start playing a tape that is inserted with the safety tab removed.

1. Press MENU on the remote to see the VCR MAIN MENU on the TV screen.
2. Press 5 to display the PREFERENCES menu.
3. Press 2 to select Auto Play: ON or OFF.
 - Select ON to have a tape with its safety tab removed start playing automatically.
 - Select OFF if you do not want a tape with its safety tab removed to start playing automatically.

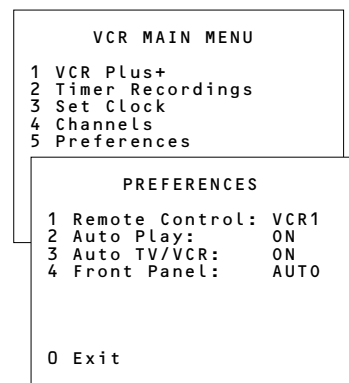

Using the Playback Features

Pause for Stop Action

This feature stops the tape in action and allows you to examine the details of the scene. Stop action works well for tapes recorded in SP or SLP speed.

1. Press PAUSE during playback to stop the action. STILL appears in the display panel.
2. Press TRACKING up or down to reduce any jittering of the picture.
3. Press PAUSE or PLAY to return to playback.

The VCR will automatically switch from stop-action playback to stop after a few minutes.

Frame Advance

Frame advance lets you view one stop-action frame after another. Frame advance works well for tapes recorded in SP or SLP speed.

1. Press PAUSE to stop the action.
2. Press F.ADV each time you want to view a frame of the scene.
3. Press PAUSE or PLAY to resume normal playback.

Slow Motion

You can view the picture in slow motion during play or play pause. SLOW up and down allow you to change the speed. Sound is turned off during slow-motion playback. Slow motion works well in SP or SLP speed.

1. Press SLOW up to start slow motion and increase the speed or SLOW down to decrease the speed.
2. Use TRACKING up or down to remove any streaks from the picture.
3. Press PLAY to return to playback.

The VCR will automatically switch from slow-motion playback to stop after a few minutes.

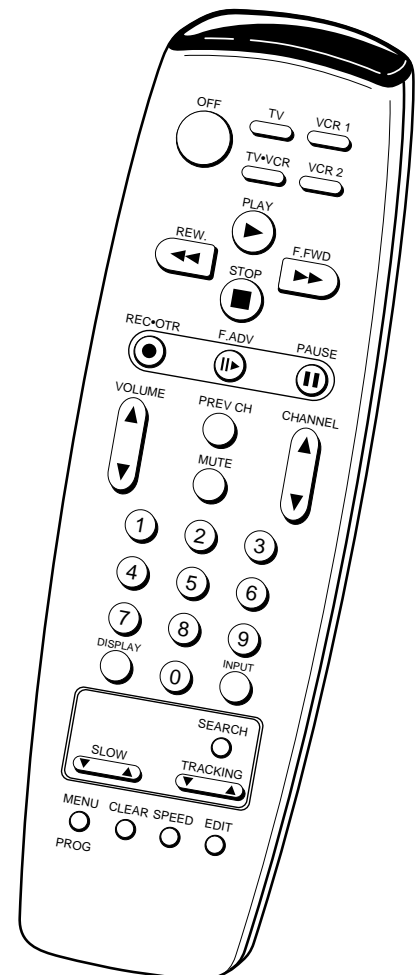

Using the Playback Features

Picture Search

You can search for a specific tape location during playback by fast forwarding or rewinding the tape. Sound is turned off during picture search. Picture search works best for tapes recorded in SP or SLP speed.

Fast Forward Search

1. During playback, press FF on the remote or FWD on the VCR to search forward at a faster-than-normal speed.
SRCH + appears in the display panel.
2. Press the button again or press PLAY to return to playback.

Rewind Search

1. During playback, press REW on the remote or VCR to search in reverse at a faster-than-normal speed.
SRCH - appears in the display panel.
2. Press the button again or press PLAY to return to playback.

Automatic Tracking

The VCR has automatic tracking which adjusts the picture when playing back a tape recorded on another VCR. Automatic tracking is turned on whenever a tape is inserted.

Manual Tracking

Occasionally, you may need to manually adjust tracking on a tape recorded on a different VCR or camcorder. Tracking is used when playing a tape, and it has no effect during recording.

- When streaks or snow appear in the picture, press TRACKING up or down on the remote or the VCR for the best possible picture.
- During pause, press TRACKING up or down on the remote to reduce any jittering of the picture.
- To turn automatic tracking back on, press both TRACKING buttons on the front of the VCR at the same time or eject the tape and re-insert it.

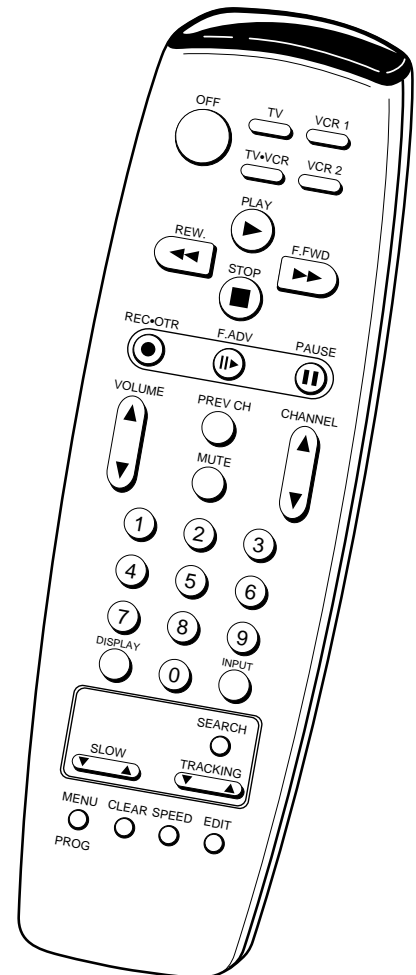

Using the Playback Features

DISPLAY Button

The DISPLAY button shows the status of the VCR channel number, time counter, date, time and tape speed on the TV screen. The time and date must be set before they can be displayed.

1. Press DISPLAY to display the status of the VCR,
If you do not press DISPLAY again, these displays will time out. The time appears in the display panel.
2. Press DISPLAY again to have only the time counter remain on the TV screen.
The time counter appears instead of the time in the VCR display panel.
3. Press DISPLAY again to remove the time counter from the TV screen.
No displays appear on the TV screen. This is convenient for copying tapes. The time counter remains in the VCR's display panel.
4. Press DISPLAY again to return to the normal status displays.
Turning off the VCR automatically returns the displays to normal.

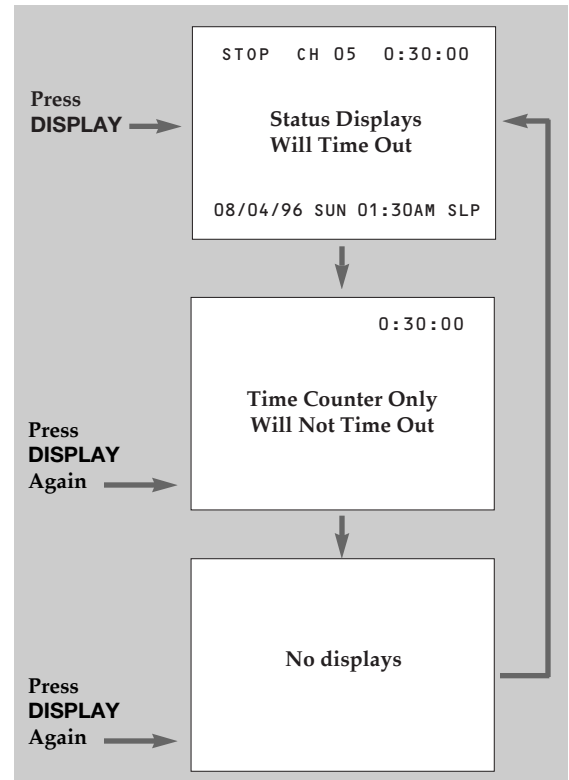

Time Counter

The time counter shows the elapsed time it takes to record a program or play back a segment of a prerecorded tape. It helps locate the beginning or end of programs you taped. The time counter resets to 0:00:00 whenever the tape is ejected from the VCR.

For example, if a 30-minute program was recorded at the beginning of the tape, you would:

1. Insert the prerecorded tape, and make sure it is rewound to the beginning. Press STOP.
2. Press DISPLAY twice to display only the time counter on the TV screen.
3. Press CLEAR to reset the time counter to 0:00:00.
4. Press F.FWD to fast forward the tape until the time counter reads 0:30:00.
5. Press STOP. This is the approximate end of the program and you can begin recording at this spot.
6. Press DISPLAY twice to remove the time counter from the screen and return to the normal displays.

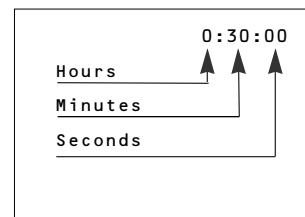

Using the Playback Features

Commercial Scan (SEARCH Button)

This is useful for scanning commercials or short program segments.

1. Press SEARCH once during playback to advance the tape approximately 60 seconds.
2. Press SEARCH twice during playback to advance the tape approximately 120 seconds.

Index Search

The VCR has a "VHS Index Search System" that automatically records an index mark on the tape every time you begin recording a program. Your VCR has two index playback features. To locate the program you want to play, select a specific index number or search by scanning.

Some index marks may be missed by the VCR.

- A mark too close to the current location on the tape.
- The mark at the beginning of a recorded segment of five minutes or less.
- The first index mark on the tape when you start searching from the beginning of the tape.

To Index Search

1. Insert the prerecorded tape and press STOP.
2. Press SEARCH on the remote to display the INDEX SEARCH menu on the TV screen.
3. Press REW or FF on the remote to scan or enter the number of index marks you want the VCR to search. Press CLEAR on the remote to correct an entry. Once the index mark or marks are found, the tape begins playback.
4. Follow the directions on the screen.

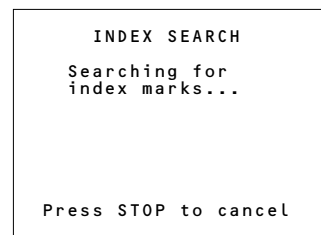
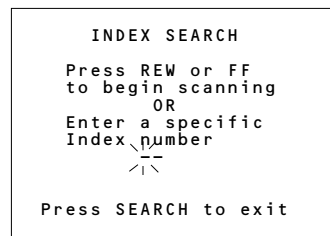

Go-To Search

The VCR searches for the time counter reading you enter and automatically begins playing back the tape.

1. Insert the prerecorded tape and press STOP.
2. Press SEARCH on the remote twice to display the GO-TO SEARCH menu on the TV screen.
3. Enter the hour(s) and minute(s) of the time counter reading you want the VCR to search. Press CLEAR on the remote to correct an entry.
4. Press REW or FF on the remote to search.
5. Press STOP to stop Go-To Searching.

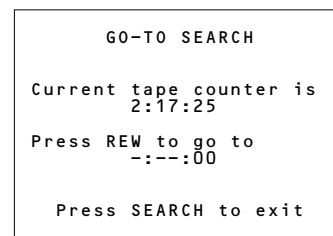

Using the Playback Features

Tape Playback: HI-FI/LINEAR/MIX Feature

The VCR records the same audio on both the Hi-Fi and linear tracks on the tape. The Hi-Fi sound is recorded on separate left and right stereo channels. Monaural sound is recorded on the linear track.

To enjoy Hi-Fi sound, connect your VCR to a stereo television or amplifier/receiver using the audio/video jacks. The Tape Playback: HI-FI/LINEAR/MIX feature lets you select which audio you play back.

To Select Playback Sound

1. Press MENU to see the VCR MAIN MENU on the TV screen.
2. Press 6 to see the AUDIO menu on the TV screen.
3. Press 2 to switch between HI-FI, LINEAR, or MIX sound.

- Select HI-FI to play back sound recorded on the Hi-Fi track and for normal use.

The Hi-Fi indicator is lit in the VCR's display panel during Hi-Fi playback.

- Select LINEAR to play back the sound recorded on the linear monaural track, such as a second audio program (SAP).

The Hi-Fi indicator turns off in the VCR's display panel during linear playback.

- Select MIX to play back the sound recorded on both the linear track and the Hi-Fi track, sound-on-sound.

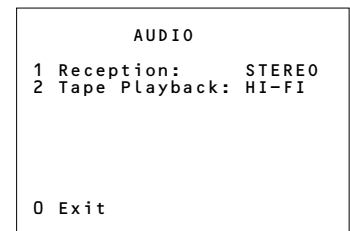
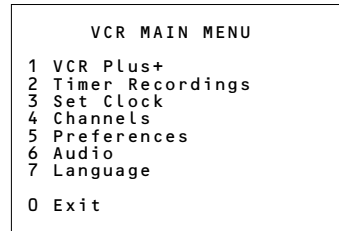

Recordings

Your VCR provides different recording options. These options are explained in this section of the manual.

Recording Speeds

Press **SPEED** on the remote to select a recording speed (SP or SLP). The speed you select appears on the TV screen. Tapes recorded in LP can be played in this VCR.

SP (Standard Play) gives the best quality recording. That is why most prerecorded, rental tapes are recorded in SP. Fewer programs can be recorded on the tape. Special effects such as pause, frame advance, slow motion, and picture search work well in this speed.



SLP (Super Long Play) gives three times the recording time of tapes recorded in SP. Special effects such as pause, frame advance, slow motion, and picture search work well in this speed.

Cassette	Recording Time	
	SP	SLP
T-120	2Hrs	6Hrs
T-160	2Hrs 40Min	8Hrs

Normal Recording

To Make a Recording

Turn on the TV and tune it to the VCR viewing channel, either 3, 4, or the TV's video input channel.

1. Insert a tape with safety tab in place.
The cassette-in indicator  lights in the VCR's display panel.
2. Press **VCR1** (**VCR2**) to set remote to control VCR.
3. If using one of the basic hookups, make sure the **VCR** indicator appears in the VCR's display panel. If not, press **TV•VCR** to turn it on.
4. Select recording speed using **SPEED** on the remote.
The tape speed indicator appears in the VCR's display panel and on the TV screen.
5. Select the channel to be recorded.
The channel number appears in the VCR's display panel and on the TV screen.
6. Press **RECORD** on the VCR or **REC•OTR** on the remote to begin recording. **REC** and  appear in the VCR's display panel while the VCR is recording.

Watch a TV Channel While VCR is Recording a Different Channel

For some cable box hookups, this recording feature may not apply. Contact your local cable company for assistance.

1. Follow steps 1 through 6 above.
2. If using one of the basic hookups, press **TV•VCR** to switch to the TV channel. The **VCR** indicator will turn off in the display panel.
3. Press **TV** to set the remote to control TV functions for a compatible TV.
4. Select the channel you want to watch with the TV's channel buttons.
5. Press **STOP** when recording is finished.

Recording While You're Away (VCR Plus+* Recording)

VCR Plus+ Setup for Antenna or Unscrambled Cable System (Not Requiring a Cable Box)

A VCR Plus+ channel number is assigned for each broadcast or cable channel. These numbers are listed in most publications that list PlusCode* numbers.

1. Prepare the worksheet on the opposing page for the VCR Plus+ channels that are different than the channels you receive them on. Refer to the chart below for standardized VCR Plus+ channel numbers.

Broadcast or Cable-TV Station Name	VCR Plus+ Channel Number	Channel Number You Receive This Station On
HBO	33	See Note 1
ESPN	34	See Note 1
ABC	See Note 2	See Note 1
FOX	See Note 2	See Note 1

Note 1: Check your local or cable listing for the channel number you receive this station on.
Note 2: Check your local listing for the broadcast or VCR Plus+ channel number assigned to this station.

2. Press MENU on the remote to display the VCR MAIN MENU on the TV screen.
3. Press 4 to display the CHANNELS menu.
4. Press 4 to display VCR Plus+ Channel List menu.
5. Using your worksheet, press two numbers to enter each channel number you receive on a **different** channel than the assigned VCR Plus+ channel number.

Press CHANNEL up or down to move the numbers up or down on the menu.

Press CLEAR on the remote to erase a number.

6. Press MENU when you are finished.
Auto channel search must be performed before setting VCR Plus+ channel list.

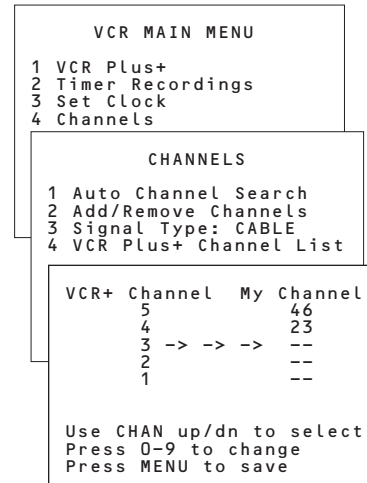

Standardized VCR Plus+ Channel Numbers for Cable-TV

U.S.A. List		Canadian List	
35 American Movie Classics	58 The Movie Channel	67 Allarcom Pay Television/Superchannel	65 MeteoMedia/The Weather Network
39 Arts & Entertainment	48 Music Television	44 Arts & Entertainment	48 MuchMusic Network
57 Black Entertainment	49 The Nashville Network	72 Cable News Network-Headline News	55 MusiquePlus
54 Bravo	38 Nickelodeon	61 Cable News Network	52 Nashville Network
42 Cable News Network	64 Nostalgia Television	70 Canadian Home Shopping Network	73 Newsworld/CBC
45 Cinemax	99 Quality Value Cable	56 Canal Famille	53 Le Reseau des Sports
98 Cinemax 2	41 Showtime	69 Cathay International Television Inc	43 The Sports Network
37 The Discovery Channel	97 Showtime 2	68 Chinavision Canada Corp	64 Super Ecran
53 The Disney Channel	59 Sports Channel	60 Country Music Television	37 Super Ecran B
63 Entertainment Television	52 Turner Network Television	63 Family Channel	98 Super Ecran C
34 ESPN Sports Network	44 USA Network	62 First Choice	66 Telatino Network
47 The Family Channel	62 Video Hits 1	96 First Choice Two	46 TV5 Montreal
33 Home Box Office	93 Viewer's Choice 1	97 First Choice Three	92 Viewer's Choice 1
95 Home Box Office 2	94 Viewer's Choice 2	99 First Choice Four	93 Viewer's Choice 2
96 Home Box Office 3	55 WGN Chicago	90 House of Commons	94 Viewer's Choice 3
51 The Learning Channel	43 WTBS Atlanta	91 La Chaîne Francaise	95 Viewer's Choice 4
46 Lifetime	60 WWOR New York	51 The Learning Channel	71 Vision TV: Canada's Faith Network
			38 Youth TV, Canada Inc

*VCR Plus+ and PlusCode are trademarks of Gemstar Development Corporation.

Recording While You're Away (VCR Plus+ Recording)

The VCR Plus+ and timer program features let you program the VCR to record up to eight different programs within a one year period. Before using VCR Plus+ to record a program, make sure that:

- The clock is set correctly.
- A tape with safety tab has been inserted with enough tape to record the program(s).
- The remote is set to control the VCR using VCR1 (VCR2).
- The VCR is setup for VCR Plus+ programming.
 - If you receive all channels through a cable box, select a cable box viewing channel on page 26.
 - If you do not use a cable box for all channels, complete VCR Plus+ Setup on page 22.

Setting a VCR Plus+ Recording

1. Press MENU on the remote to display the VCR MAIN MENU on the TV screen.
2. Press 1 to display the VCR PLUS+ menu.
3. Press numbers on the remote to enter the PlusCode number for the program you want to record. VCR PlusCode numbers are found in most local TV listings.
Press CLEAR on the remote to correct an entry.

4. Press MENU to enter the program.
If the VCR does not recognize the PlusCode number, Unrecognized number... Please re-enter appears on the TV screen. Check the number and enter it again.

5. Press 1, 2, 3, or 4 to select type of program.
 - 1 One time – single program recorded once.
 - 2 Daily – program recorded at same time every day.
 - 3 Weekdays – program recorded at same time Monday through Friday.
 - 4 Weekly – program recorded at same time once a week.

6. Select recording speed using SPEED on the remote.
7. Press CLEAR if you want to change the program end time.

This feature allows you to extend the recording time on VCR Plus+ programs. This option may be useful when recording programs such as sporting events that could go past scheduled broadcast times.

8. Press MENU to enter your program. A reminder appears which times out.
PROGRAMS OVERLAP may appear on the screen if you entered two programs where the times overlap.
9. The TIMER RECORDINGS menu appears. Press 3 to enter an additional VCR Plus+ program, or press 0 to exit.
10. **Turn off the VCR** before recording time.
TIMER appears briefly and TIMER appears in the VCR's display panel when the timer has been programmed.
11. **If using a cable box or satellite receiver, leave it turned on and tuned to the channel you want to record.**

VCR MAIN MENU

1 VCR Plus+

VCR PLUS+

Enter PlusCode number
(from TV listing)

1
2
3
4

How often should this
Program record?

1 One time
2 Daily (every day)
3 Weekdays (M - F)
4 Weekly (once per week)

Program 1 (One Time)

Channel 08
Start Time 02:10 PM
End Time 03:35 PM
Start Date 08/04/96 Sun
Tape Speed SLP

Press CLEAR to correct
Press MENU to save

Stopping a Recording in Progress

With the VCR: Press POWER and then STOP within a few seconds.

With the Remote: Press VCR1 (VCR2) and then STOP within a few seconds.

Recording While You're Away (Timer Recording)

The VCR Plus+ and timer program features let you program the VCR to record up to eight different programs within a one year period. Before setting the timer, make sure that:

- The clock is set correctly.
- A tape with safety tab has been inserted with enough tape to record the program(s).
- If you receive all channels through a cable box, select a cable box viewing channel *on page 26*.

Setting a Timer Recording

1. Press MENU on the remote to display the VCR MAIN MENU.
2. Press 2 to display the TIMER RECORDINGS menu.
3. Press 1 to display the Create a New Program menu.
4. Press 1, 2, 3, or 4 to select type of program.
 - 1 One time — single program recorded once.
 - 2 Daily — program recorded at same time every day.
 - 3 Weekdays — program recorded at same time Monday through Friday.
 - 4 Weekly — program recorded at same time once a week.
5. Press number buttons on the remote to enter the channel number (or INPUT to select the line input), start time including AM or PM, end time, and start date of the recording. Just follow the on-screen prompts. Press CLEAR to correct an entry.

If you receive all channels from a cable box and have completed *Cable Box Setup on the next page*, the output channel of your cable box will automatically appear on the menu.
6. Select recording speed using SPEED or the number buttons on the remote.
7. Press MENU to enter your program. A reminder appears which will time out.

PROGRAMS OVERLAP may appear on the screen if you entered two programs where the times overlap.
8. The TIMER RECORDINGS menu appears. Press 1 to enter an additional timer program, or press 0 to exit.
9. **Turn off the VCR** before recording begins.

TIMER appears briefly and TIMER appears in the VCR's display panel when the timer has been programmed.
10. **If using a cable box, leave it turned on and tuned to the channel you want to record.**

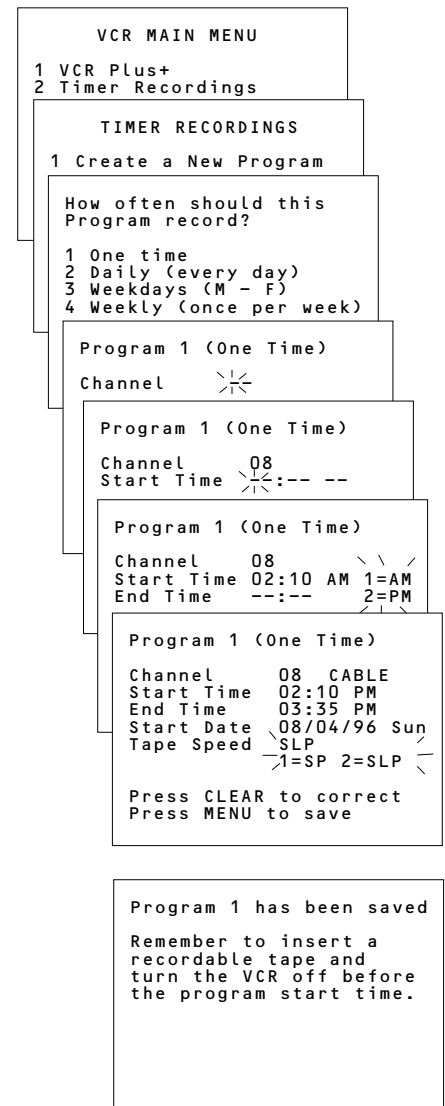

Stopping a Recording in Progress

With the VCR: Press POWER and then STOP within a few seconds.

With the Remote: Press VCR1 (VCR2) and then STOP within a few seconds.

Recording While You're Away (Timer Recording)

Select Cable Box Viewing Channel

If you have a cable box, follow the directions below.

1. Press MENU on the remote to display the VCR MAIN MENU on the TV screen.
2. Press 4 to display CHANNELS menu.
3. Press 5 to display Cable Box Setup menu.
4. Select one of the three options:

1 ALL Channels

- Press 1 for ALL channels and then enter two numbers for the output channel of your cable box. (Valid numbers are 01-13.)
 - Press CLEAR to correct an entry.
- If you connected your cable box to the VCR using the cable box's AUDIO/VIDEO OUT jacks, press INPUT on the VCR to select VIDEO IN option.

- Press MENU PROG. A message appears which will time out or press MENU PROG to return to VCR MAIN MENU.

VCR will now automatically enter the output channel of your cable box in the VCR Plus+ or Timer Recordings menu.

2 Only SOME Channels

Skip this setup if your cable box is not required for all channels.

- Press 2 for Only SOME channels.
- Press MENU to continue.

3 Cancel setup

- Press 3 to cancel the CABLE BOX SETUP feature.
- Press MENU to continue.

VCR MAIN MENU

- 1 VCR Plus+
- 2 Timer Recordings
- 3 Set Clock
- 4 Channels

CHANNELS

- 1 Auto Channel Search
- 2 Add/Remove Channels
- 3 Signal Type: ANTENNA
- 4 VCR Plus+ Channel List
- 5 Cable Box Setup

CABLE BOX SETUP

Do you use your cable box to receive ALL channels or only SOME channels?

- 1 ALL channels
- 2 Only SOME channels
- 3 Cancel setup

CABLE BOX SETUP

On what channel does the VCR receive signals from the cable box? (usually 3, 4 or Video)

--

Press 01-13 or INPUT
Press MENU to cancel

CABLE BOX SETUP

The feature works only if the cable box is used to receive ALL channels.

Consult your User's Manual for assistance.

Press MENU to continue

CABLE BOX SETUP

The Cable Box Setup was canceled.

The VCR will NOT control the cable box channel during timer recordings.

Press MENU to continue

Recording While You're Away (Timer Recording)

Checking or Clearing Timer Recordings

1. Press MENU on remote to display VCR MAIN MENU on TV screen.
2. Press 2 to display the TIMER RECORDINGS menu.
3. Press 2 for Review Existing Progs. feature.
4. Press MENU PROG to display the next program.
5. Press CLEAR when the program you want to erase appears on the screen.

Timer Recording From the VCR's Line Input

The line input refers to the signal coming from the AUDIO and VIDEO IN jacks of the VCR. Recording from the line input is convenient if you have a satellite receiver or similar component attached to these jacks. To timer record from the component connected to the VCR's line input:

Press INPUT to enter VIDEO instead of the channel number on the TV screen during timer programming.

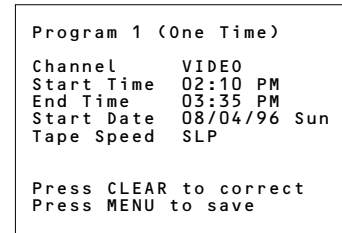
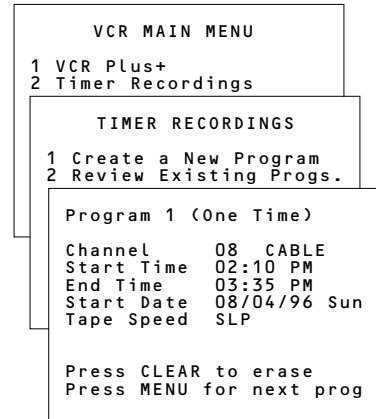

One Touch Recording

One touch recording lets you record up to four hours without using the timer program feature. The VCR will turn off automatically at the end of the recording.

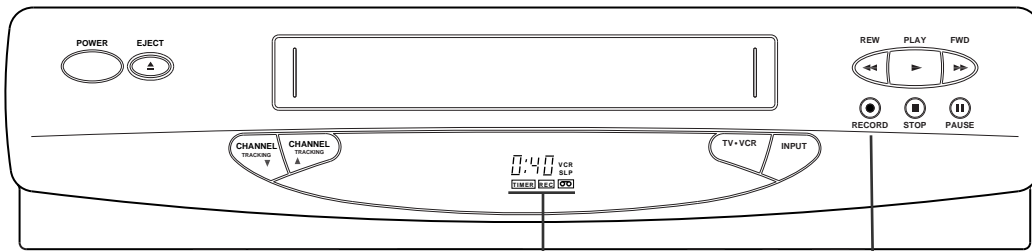

Display showing 40 minutes remaining for recording.

RECORD

1. Turn on the VCR.
2. Insert a tape with safety tab in place.
3. Select the channel you want to record.
4. Select the desired recording speed using SPEED on the remote.
5. Press RECORD on the VCR or REC•OTR on the remote to activate recording.
6. Press RECORD on the VCR or REC•OTR on the remote repeatedly until the amount of recording time for the program is displayed in the VCR's display panel or on the TV screen.

Press REC•OTR	Recording Time
0:30	(30 Min)
1:00	(1 Hr)
1:30	(1 Hr, 30 Min)
2:00	(2 Hrs)
3:00	(3 Hrs)
4:00	(4 Hrs)
0:00	(Recording Turns Off)

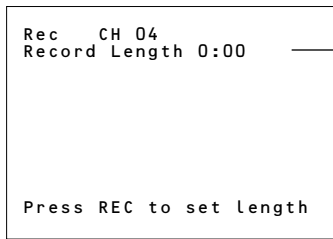

Display on TV Screen

Each press increases the time — 30 minutes up to 4 hours.

The amount of time the VCR will record and the **REC** and **TIMER** indicators appear in the VCR's display panel.

Stopping a Recording in Progress

With the VCR: Press POWER and then STOP within a few seconds.

With the Remote: Press VCR1 (VCR2) and then STOP within a few seconds.

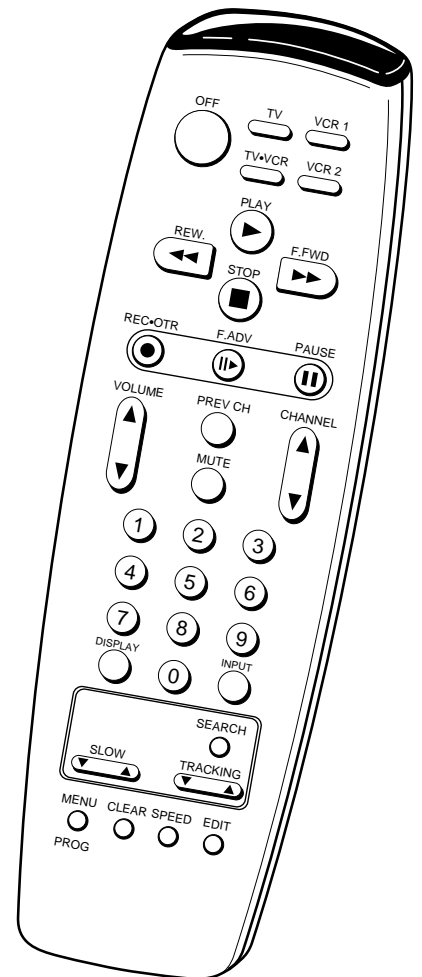

Recording Broadcast Stereo TV or SAP (Second Audio Program)

Some TV programs are broadcast with stereo audio or a second audio language (SAP). The Reception: STEREO/MONO/SAP feature lets you select the type of audio you want to record.

To Record Stereo Broadcast TV or SAP

Turn on the TV and tune it to the VCR viewing channel, either 3, 4, or TV's video input.

1. Insert a tape with safety tab in place.
2. If using one of the basic hookups, make sure the VCR indicator appears in the VCR's display panel. If not, press TV•VCR to turn it on.
3. Use SPEED on the remote to select a recording speed.
The tape speed indicator appears in the VCR's display panel and on the TV screen.
4. Select the channel or line input to be recorded.
Channel number or LINE appears in the VCR's display panel.
5. Set the Reception: STEREO/MONO/SAP feature for the type of audio you want to record.
 - A. Press MENU to display the VCR MAIN MENU on the TV screen.
 - B. Press 6 to display the AUDIO menu.
 - C. Press 1 to select the type of audio Reception: STEREO, MONO, or SAP.
 - Set to STEREO for normal recording and to record broadcast stereo TV.
The STEREO indicator lights in the VCR's display panel when the station you are tuned to is broadcasting stereo.
 - Set to MONO if the stereo signal is weak and the sound is too "noisy".
 - Set to SAP to record SAP (second audio program) instead of the normal audio on both the hi-fi and linear tracks.
The SAP indicator lights in the VCR's display panel when the station you are tuned to is broadcasting SAP.
 - D. Repeatedly press 0 to remove the menus from the TV screen.
6. Press REC•OTR on remote or RECORD on the VCR to start recording. REC and  appear in the VCR's display panel.
7. Press STOP when you are finished.

```
VCR MAIN MENU
1 VCR Plus+
2 Timer Recordings
3 Set Clock
4 Channels
5 Preferences
6 Audio
7 Language
0 Exit
```

```
AUDIO
1 Reception: STEREO
2 Tape Playback: HI-FI
0 Exit
```

Recording Audio Only

You can record audio only from another audio source connected to the AUDIO IN (L and R) jacks on the back of the VCR.

To Record Audio Only

1. Press the INPUT button until the line indicator (VIDEO) appears on the TV screen.
The VCR will record audio from the audio equipment connected to the AUDIO IN jacks.
2. Use SPEED on the remote to select the recording speed.
The tape speed indicator appears in the VCR's display panel and on the TV screen.
3. Make sure the Reception: STEREO/MONO/SAP feature is set to STEREO.
 - A. Press MENU to display the VCR MAIN MENU on the TV screen.
 - B. Press 6 to display the AUDIO menu.
 - C. Press 1 to select Reception: STEREO.
4. Start audio source playing and press REC•OTR on remote or RECORD on the VCR to begin recording.
REC and  appear in the VCR's display panel.
5. Press STOP when you are finished.

```
VCR MAIN MENU
1 VCR Plus+
2 Timer Recordings
3 Set Clock
4 Channels
5 Preferences
6 Audio
7 Language
0 Exit
```

```
AUDIO
1 Reception: STEREO
2 Tape Playback: HI-FI
0 Exit
```

To Playback Audio Only

Connect the AUDIO OUT of the VCR to the appropriate input on your amplifier or receiver. Do not use the phono input. Refer to your amplifier or receiver user's guide for information.

Recording Features

Recording Pause

To prevent recording short passages of unwanted material, use PAUSE during recording to stop and start recording. The VCR automatically switches from pause to stop after a few minutes.

Using Two VCRs for Copying and Editing Tapes

Operating Instructions (Refer to hookup on page 6.)

Use one VCR as the playback VCR and the other as the recording VCR. If you have two compatible VCR's, use the AutoEdit feature *described below*.

Caution: The unauthorized recording of television programs and other materials may infringe the rights of others.

1. Turn on the TV and VCRs.
2. Tune TV to the VCR viewing channel, either 3, 4, or TV's video input.
3. If you have connected your VCR using Option A (*page 6*), tune recording VCR to channel 3 or 4 — the one selected on the back of the playback VCR.
If you have connected your VCR using Option B (*page 6*), press INPUT on recording VCR to select the line input. LINE appears in VCR's display panel.
4. Insert the tape you want to copy into playback VCR. Insert a blank tape with safety tab in place into recording VCR.
5. Press PLAY, then PAUSE on playback VCR when you reach the point on the tape or program where you want to begin copying. If the tape was not recorded on the playback VCR, streaks may appear and you may need to adjust tracking. To prevent on-screen displays on the playback VCR from appearing on the recording, press DISPLAY button three times. *See page 18.*
6. Press RECORD, then PAUSE, on recording VCR.
7. Press PAUSE buttons on both VCRs at the same time to begin copying the tape.*
8. Edit out segments that you do not want to copy by pressing PAUSE on recording VCR to stop copying the tape. Then locate the next segment you want to copy on the playback VCR by using FWD, REW, and PLAY. Press PAUSE on the playback VCR. Press PAUSE at the same time on both VCRs to resume copying.
9. Press STOP on both VCRs when you are finished.

* You may turn off the TV after the recording has started as it does not have to be on to copy a tape.

Using Dual Remote with AutoEdit™

Use this VCR as the recording VCR and set it to respond to VCR2 on the remote *as described on page 13*. Use your other compatible VCR as the playback VCR, which should respond to VCR1.

1. Follow steps 1 – 4 in the "Operating Instructions" above.
2. Press VCR2 on remote to control recording VCR. Press REC•OTR, then PAUSE, to put recording VCR in pause mode.
3. Press VCR1 on remote to control playback VCR.
4. Use F.FWD, REW, and PLAY to locate the point where you want to begin copying. Press PAUSE while VCR is playing to put playback VCR in pause mode.
5. Press EDIT on remote; the VCRs will begin copying.
6. Press EDIT again when you want to stop the tape from copying.
7. Repeat steps 4 – 6 as needed.
8. Press VCR1, STOP, then VCR2, STOP, when you are finished.

Location of Controls

Front Panel

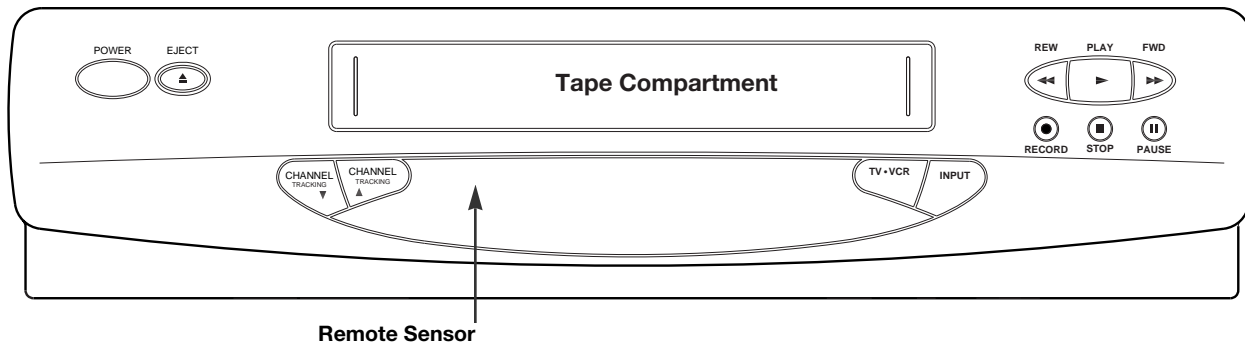

CHANNEL/TRACKING Up or Down

Selects next higher or lower channel in the VCR's channel memory.

Adjusts tracking when a tape is playing.

EJECT

Press when the VCR is stopped to eject the cassette.

FWD (Fast Forward)

Fast forwards the tape when the VCR is stopped.

Searches the picture forward during playback.

INPUT

Turns the line input on or off.

Line input refers to the signal coming from the component connected to the audio/video jacks on the back of the VCR.

PAUSE

Pauses action for viewing during playback.

Pauses recording to prevent recording of unwanted scenes.

PLAY

Plays a tape.

POWER

Turns the VCR on or off.

RECORD

Starts VCR recording.

Used for one touch recording.

Remote Sensor

Receives signals from the remote control.

Aim the remote at this sensor with no objects between them.

REW

Rewinds the tape when the VCR is stopped.

Searches the picture in reverse during playback.

STOP

Stops the normal functions such as record, playback, rewind, fast forward, or pause.

TV•VCR

Switches the picture signal so that it either comes from the VCR or the TV channel.

See page 10.

Location of Controls

Back Panel

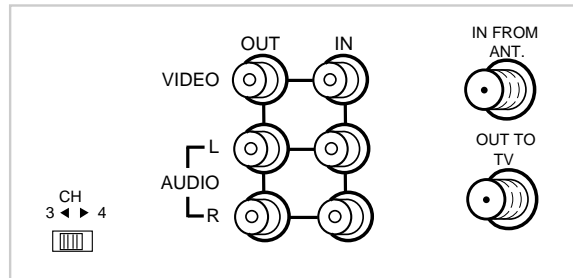

CH 3 ◀ ▶ 4 Switch

Selects the channel to which you will tune the TV to see the VCR picture if you connect the VCR using one of the basic hookups.

IN FROM ANT. (Antenna) Connector

Receives the signal from an antenna or cable system that is attached to this connector.

OUT TO TV Connector

Passes signal to TV using the cable supplied.

VIDEO and AUDIO R (Right) and L (Left) IN Jacks

Receives signals from another component, like a VCR or camcorder, when it is connected to these jacks.

Use INPUT to select.

VIDEO and AUDIO R (Right) and L (Left) OUT Jacks

Sends signals from VCR to another component, like a TV monitor or VCR, when it is connected to these jacks.

Location of Controls

Display Panel

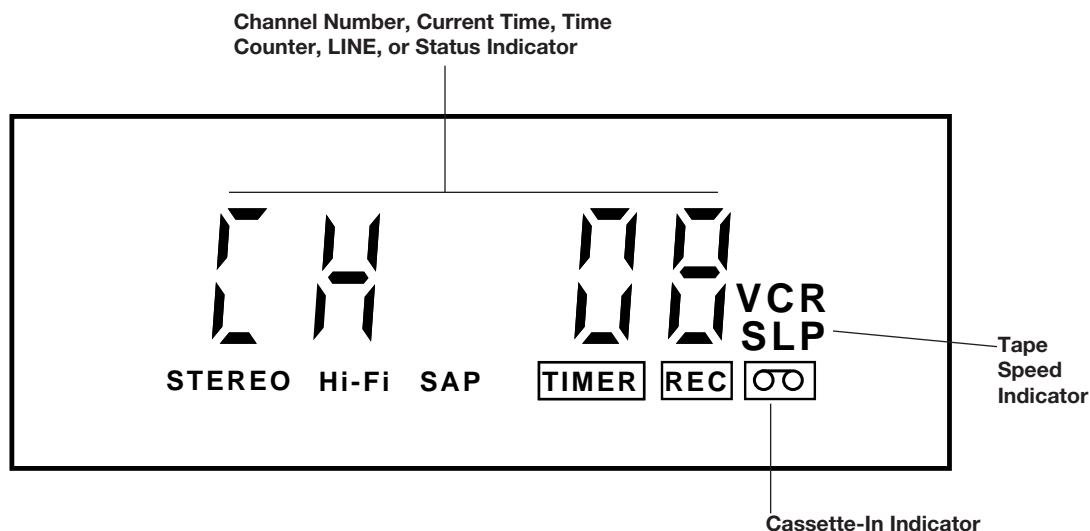

Cassette-in Indicator ()

Lights when a tape is in the VCR.

Channel Number or LINE

The channel number or line input is displayed.

Press INPUT to display LINE to record from the VIDEO and AUDIO IN jacks.

Hi-Fi Indicator



Lights when the Playback: HI-FI/LINEAR /MIX feature is set to HI-FI or MIX.

SAP Indicator

Lights when the station you are tuned to is broadcasting SAP.

Status Indicators

Show what the VCR is doing.

EJECT	Ejecting tape
F-FWD	Fast forward
PLAY	Playback
PAUSE and 	Record pause
REC and 	Record
REW	Rewind
SLOW	Slow motion
SRCH +	Forward search
SRCH -	Reverse search
STILL	Play pause and Frame advance
STOP	VCR stopped
X-REC	One touch recording

STEREO Indicator

Lights when the station you are tuned to is broadcasting stereo.

Tape Speed Indicators (SP or SLP)

Press SPEED on the remote to change.

Time or Time Counter

Press DISPLAY to switch between the current time and elapsed-time counter.

Indicator

Lights when VCR is set for timer recording and VCR is turned off.

Flashes if tape is not inserted.

VCR Indicator (Applies Only to Basic Hookups)

Press TV•VCR to turn on or off.

VCR indicator on: Picture from VCR.

VCR indicator off: Picture from TV channel.

Specifications

Format:	VHS
Record/Playback System:	Video: 4-Head Audio: 2 Hi-Fi record/playback system
Video Signal System:	EIA standard: NTSC color
Antenna:	75-ohm external VHF/UHF combined antenna terminal
Tuner:	USA: 181 channels capability* (125 cable channels) Canada: 178 channels capability* (122 cable channels)
Type:	AutoProgramming frequency synthesis
Power Requirement:	120V AC, 60 Hz
Power Consumption:	19 watts
Dimensions:	3.6 inches high (91.5 mm) 15.4 inches wide (390 mm) 12.5 inches deep (318.5 mm)
Weight:	8.8 pounds (4.0 kg)
Storage Temperature Range:	- 22°F to +149°F (-30°C to +65°C)
Operating Temperature Range:	+41°F to +104°F (+5°C to +40°C)

*Check your cable company's compatibility requirements.

Cleaning the VCR

Use a soft cloth or dusting attachment of your vacuum cleaner to dust your VCR. Remove dust from the ventilation holes on the top, back, sides, and bottom of the cabinet.

Plastic surfaces are easily scratched and can be marred by alcohol and various solvents. Avoid excessive use of oil-based furniture polishes since the materials used in the cabinet will accumulate more dust. We recommend using a non-abrasive, anti-static cleaner and polisher.

Trouble Checks

Sometimes problems can be easily solved by checking a few basic things. Check below before you call for help or take your VCR to an Authorized GE VCR Servicenter.

Trouble	Here's what to try:
No power	<ul style="list-style-type: none"> • Plug VCR into an operating outlet. • Check connections.
Remote locks up	<ul style="list-style-type: none"> • Remove batteries and hold down one or more buttons for several seconds to drain the microprocessor inside the remote to reset it. Re-install the batteries and try remote again.
VCR does not respond to remote	<ul style="list-style-type: none"> • Press VCR1 (VCR2) to set remote to control the VCR. <i>See page 13.</i> • Aim remote at VCR with no objects between them. • Change batteries.
GE TV does not respond to remote	<ul style="list-style-type: none"> • Press TV to set remote to control a compatible TV. <i>See page 14.</i> • Reprogram remote for GE TV. <i>See page 14.</i>
Remote no longer controls a compatible TV	<ul style="list-style-type: none"> • Press TV to set remote to control a compatible TV. <i>See page 14.</i>
VCR only responds to VCR2 button on remote	<ul style="list-style-type: none"> • Check setting of Remote Control: VCR1/VCR2 feature. <i>See page 13.</i>
Poor or no picture for normal TV viewing	<ul style="list-style-type: none"> • Press TV•VCR to turn VCR indicator off. • Switch TV to an active channel. • Check antenna connections.
Snowy or no picture during playback	<ul style="list-style-type: none"> • Press TV•VCR to turn VCR indicator on. • Check TV channel selected (3 or 4) to make sure it matches the channel selected with CH3 CH4 switch on back of VCR. • Check TV's fine tuning. • Check video cable connections between VCR and TV monitor. • Set TV monitor to video input channel. • Try another tape. • Some snow/streaks are normal during search, frame advance, slow motion, and stop action playback.
Streaks in picture during normal playback	<ul style="list-style-type: none"> • Press one of the TRACKING buttons to move streaks up or down and out of the picture. • Check tape — it may be worn out or of poor quality.
Time counter not working	<ul style="list-style-type: none"> • The time counter does not advance during unrecorded portions of tape. When an unrecorded segment of tape is encountered, the time counter will hold its count until recorded material is detected again. • A minus (-) will appear in front of the time if you rewind the tape farther back than a counter reading of 0:00:00.
Will not record or play	<ul style="list-style-type: none"> • No cassette in VCR. • Eject and re-insert cassette. • Broken tape — try another cassette. • VCR is in pause mode. Press PAUSE.
Will not record	<ul style="list-style-type: none"> • Safety tab removed from cassette. • Make sure LINE does not appear in VCR's display panel for normal recording from the VCR's tuner. Press INPUT to turn off the line input.

Trouble Checks

Trouble	Here's what to try:
Rewind does not operate	<ul style="list-style-type: none"> • Tape already rewound.
VCR plus+ or timer recording not made or wrong program recorded	<ul style="list-style-type: none"> • Wrong VCR plus+ code entered. • Cable box was not turned on at time recording was to begin. • Program entered incorrectly (wrong channel or times). • Power interruption. Clock area in display panel shows --:--. Reset clock. <i>See page 9.</i> • Check to see if time and date are correct — including AM/PM. • Program exceeded tape's length or tape was not rewound beforehand. • VCR was not turned off at the time recording was to start. • No tape in VCR or cassette's safety tab broken off.
VCR makes noise when stopped	<ul style="list-style-type: none"> • VCR is removing tape from heads. This is normal. The head cylinder inside the VCR will continue to rotate for a few minutes after you put the VCR in the stop mode.
Will not auto search active channels correctly	<ul style="list-style-type: none"> • Check antenna connections. • Check Signal Type: CABLE/ANTENNA feature. <i>See page 8.</i>
Cannot add or remove channels	<ul style="list-style-type: none"> • Channels must be placed in memory using Auto Channel Search feature before channels can be added or removed from channel memory. <i>See page 9.</i>
Tape plays back in slow motion	<ul style="list-style-type: none"> • Press PLAY to return to normal playback.
Cannot select channels over 69	<ul style="list-style-type: none"> • Cable channels over 69 can only be selected if Signal Type: CABLE/ANTENNA feature is set to CABLE. <i>Details are on page 8.</i>
Cassette with safety tab removed does not start to play automatically	<ul style="list-style-type: none"> • Set Auto Play ON/OFF feature to ON. <i>Details are on page 15.</i>
No status displays appear on the TV screen when you change channels, etc.	<ul style="list-style-type: none"> • Display off mode is selected. Press DISPLAY. <i>See page 18.</i>
Stereo or SAP sound not recorded	<ul style="list-style-type: none"> • Reception: STEREO/SAP/MONO feature must be set to STEREO to record broadcast stereo. <i>See page 29.</i> • Reception: STEREO/SAP/MONO feature must be set to SAP to record SAP. <i>See page 29.</i> • STEREO or SAP indicator not on. Station not broadcasting stereo or SAP.
No stereo sound during playback	<ul style="list-style-type: none"> • Playback: HI-FI/MIX/LINEAR feature must be set to HI-FI to hear stereo sound during playback. <i>See page 20.</i>
Stereo audio too noisy	<ul style="list-style-type: none"> • Stereo signal is weak. Set Reception: STEREO/SAP/MONO feature to MONO. • Press one of the TRACKING up or down buttons to minimize the noise.

Limited Warranty

What your warranty covers:

- Any defect in material or workmanship.

For how long after your purchase:

- Ninety days for labor charges.
- One year for parts.
- The warranty period for rental units begins with the first rental.

What we will do:

- Pay any Authorized GE VCR Servicenter the labor charges to repair your VCR.
- Pay any Authorized GE VCR Servicenter for the new or, at our option, refurbished replacement parts required to repair your VCR.

How you get service:

- Take your VCR to any Authorized GE VCR Servicenter. To identify your nearest Authorized GE VCR Servicenter, ask your dealer, look in the Yellow Pages, or call 1-800-447-1700.
- Show the service technician your evidence of purchase date.
- Pick up your VCR when repairs are completed.

What your warranty does not cover:

- Customer instruction. (Your Owner's Manual clearly describes how to install, adjust, and operate your VCR. Any additional information should be obtained from your Dealer.)
- Installation and related adjustments.
- Signal reception problems not caused by your VCR.
- Damage from misuse or neglect.
- Cleaning of video/audio heads.
- Remote control batteries.
- A VCR that has been modified or incorporated into other products or is used for institutional or other commercial purposes.
- A VCR purchased or serviced outside the USA.
- Acts of God, such as but not limited to lightning damage.

Product Registration:

- Please complete and mail the *Product Registration Card* packed with your VCR. It will make it easier to contact you should it ever be necessary. The return of the card is not required for warranty coverage.

How state law relates to this warranty:

- This warranty gives you specific legal rights, and you also may have other rights that vary from state to state.



If you purchased your VCR outside the United States:

- This warranty does not apply. Contact your dealer for warranty information.

Index

- Accessories, Included 7
- Add or Remove Channels from Memory 9
- ADD/REMOVE CHANNEL Menu 9
- Antenna Connections 2,3
- AUDIO and VIDEO Jacks 3-6,27,29,33
- AUDIO Menu 20,29,30
- Audio Recording 30
- Auto Play Feature 15
- Auto TV/VCR Feature 9,15
- Auto Channel Search Feature 8
- AUTO 10
- AutoEdit 31
- Back Panel 33
- Batteries, Inserting in Remote 7
- BRIGHT 10
- Brightness 10
- Broadcast Stereo, Recording 29
- Cable Box Viewing Channel 26
- Cable System With Cable Box Connections . . 2,3-5
- Cable System Without Cable Box Connections . 2,3
- Card, Registration i
- Cassette, Insert 15
- CH3◀▶4 Switch 3-6,8,10,33
- CHANNEL Up or Down Button 8,9,11,12,32
- CHANNELS Menu 8,9,22
- Checking Timer and VCR Plus+ Programs . . . 27
- Checks, Trouble 36,37
- Choosing a Hookup 2
- Cleaning the VCR 35
- CLEAR Button 9,11,18,24,25,27
- Clearing Timer and VCR Plus+ Programs 27
- Commercial Scan 19
- Component Buttons 11
- Connections
 - Antenna 2,3
 - Cable System with Cable Box for All
 - Channels 2,4
 - Cable System with Cable Box for Pay
 - Channels 2,5
 - Cable System with No Cable Box 2,3
 - VCR for Tape Copying 2,6
- Contents 1
- Controlling a TV 14
- Copying Tape, Connections 6
- Copying Tapes 31
- Date and Time, Setting 9
- Design Specifications 35
- DIM 10
- DISPLAY Button 11,18
- Display Panel 10,34
- Displays, Status 18,34
- EDIT Button 11,31
- Editing Tapes 31
- English 8
- EJECT Button 15,32
- F.ADV (Frame Advance) Button 11,16
- FF or FWD (Fast Forward)
 - Buttons 11,17-19,31,32
- First-Time Operation 7-10
- Frame Advance 16
- French 8
- Front Panel 32
- GO-TO SEARCH Menu 18
- Hi-Fi Indicator 20,34
- Hook-Ups
 - Antenna 2,3
 - Cable System with Cable Box for All
 - Channels 2,4
 - Cable System with Cable Box for Pay
 - Channels 2,5
 - Cable System with No Cable Box 2,3
 - VCR for Tape Copying 2,6
- Idioma 8
- IN FROM ANT (Antenna) Connector 3-6,33
- INDEX SEARCH 19
- INPUT Button 11,27,29-34
- Insert Cassette 15
- Language 8
- Langue 8
- Limited Warranty 38
- LINE Indicator 27,31,34
- Line Input, Recording From 27
- Location of Controls
 - Remote Control 11,12
 - VCR Back Panel 33
 - VCR Display Panel 34
 - VCR Front Panel 32
- MENU PROG Button 8-11,20,22,24-27,29
- MUTE Button 11,12
- Normal Recording 21
- Number Buttons 11,12
- OFF Button 11,14
- On-Screen Displays 18
- One Touch Recording 28
- One Touch recording, Stopping 28
- Operation, First Time 7-10
- Operating Instructions
 - Copying Tapes 31
 - Normal Recording 21
 - One Touch Recording 28
 - Playing a Tape 15
 - Recording Audio Only 30
 - Recording Broadcast Stereo or SAP 29
 - Timer Recording 25
 - VCR Plus+ Recording 22-24
- OUT TO TV Connector 3-6,33
- PAUSE Button 11,12,16,30-32
- Pause for Stop Action 16
- Pause, Recording 30
- Picture Search 17

Index

- PLAY Button11,12,15,16,20,31,32
- Playback : HI-FI/LINEAR/MIX Feature20
- POWER Button24,25,28,32
- PREFERENCES Menu9,10,15
- PREV CH (Previous Channel) Button11,12
- Problems, Solving36,37
- Product Registrationi
- Programming Remote to Control VCR13
- PROGRAMS OVERLAP Message24,25
- REC and  Indicators21,28,31,34
- Reception: STEREO/MONO/SAP Feature . . .29,30
- RECORD and REC•OTR
 - Buttons11,12,21,24,25,31,32
- Recording
 - Audio Only30
 - Broadcast Stereo29
 - Normal21
 - One-Touch28
 - SAP (Second Audio Program)30
 - Timer25
 - VCR Plus+22-24
 - Watching One Program While Recording
 - Another21
- Recording Audio Only30
- Recording Broadcast Stereo29
- Recording, Normal21
- Recording SAP29
- Registration Cardi
- Remote Control11-14
- Remote Control: VCR1/VCR2 Feature13
- Remote Sensor32
- Remove or Add Channels from Memory9
- REMOVE/ADD Channel Menu9
- REW (Rewind) Button11,12,17,18,31,32
- Safety Precautionsi
- Safety Tab15
- SAP Indicator29,34
- SAP, Recording29
- SEARCH Button11,12,19
- Search, Picture17
- Seleccione el idioma8
- Sélectionner la langue8
- Sensor, Remote32
- SET CLOCK Menu9
- Setting Up the VCR7-10
- Signal Type: CABLE/ANTENNA Feature8
- SLOW Buttons11,12,16
- Slow Motion16
- SLP Speed21
- SP Speed21
- Spanish8
- Specifications35
- SPEED Button11,12,21,24,25,28,31
- Speeds, Recording21
- Status Displays18
- Status Indicators34
- STEREO Indicator29,34
- Stereo TV, Recording29
- STOP Button11,12,32
- Stop Action Pause16
- Stopping a
 - One Touch Recording28
 - Timer Recording25
 - VCR Plus+ Recording24
- Table of Contents1
- Tape Playback: HI-FI/LINEAR/MIX Feature . . .20
- Tape Speed Indicators21,34
- Tape, Playing15
- Tapes, Copying31
- Tapes, Editing31
- Time and Date, Setting9
- Time Counter18,34
- Time Display34
- Timer Recording
 - Checking and Clearing27
 - Setting a Recording25
 - Stopping a Recording25
 - TIMER and  Indicators34
 - TIMER RECORDINGS Menu24,25
- TIMER RECORDINGS Menu25
- TRACKING Buttons11,12,17,32
- Trouble Checks36-37
- Turn On VCR7
- TV Button11,14
- TV Function Buttons12,14
- TVs, Compatible Chart14
- TV•VCR Button9,10,11,12,32
- VCR Controls32-34
- VCR Function Buttons11,12,13
- VCR Indicator9,10,15,34
- VCR MAIN MENU8,9,10,20,24-30
- VCR Plus+ Recording
 - Checking and Clearing27
 - Setting a Recording24
 - Standard Channels22
 - Stopping a Recording24
 - VCR PLUS+ Menu24
 - VCR Plus+ Worksheet23
- VCR, Cleaning35
- VCR, Turn On7
- VCR1 and VCR2 Buttons11,13,31
- VCRs Memory, Placing Channels8
- VCRs, Connecting for Tape Copying16
- VOLUME Buttons11,12
- Warranty, Limited38
- Watch One Channel While Recording
 - Another21
- Worksheet, VCR Plus+23

For your nearest Authorized Servicenter
call toll-free in the U.S.A.

1-800-447-1700

Canadian Consumers –
Your toll-free numbers are:

English: 1-800-522-0338

French: 1-800-522-0445

Please do not send any products to the Indianapolis address
listed in this manual or on the carton. This will only add
delays in service for your product.

 **THOMSON CONSUMER ELECTRONICS**

**10330 N. Meridian Street
Indianapolis, IN 46290**

©1996 Thomson Consumer Electronics, Inc.

Trademark(s)[®] Registered

Marca(s) Registrada(s)

Printed in Korea

Part Number 96-VG4258-1